

FIJOS

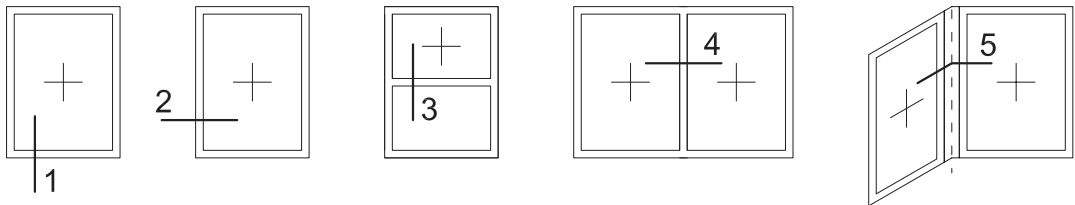

VENTANAS

Ap. Interior

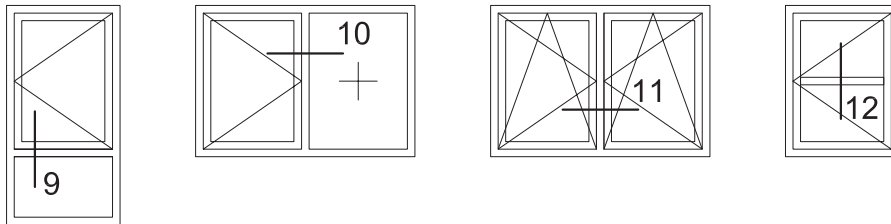
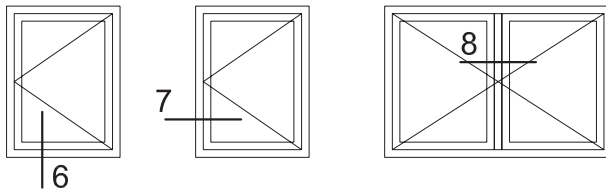

Ap. Exterior

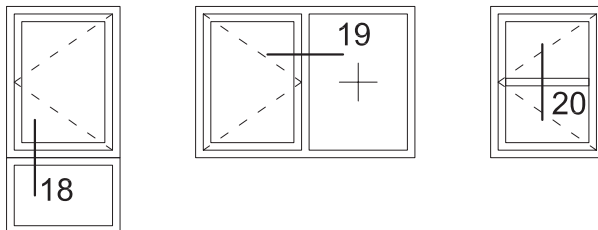
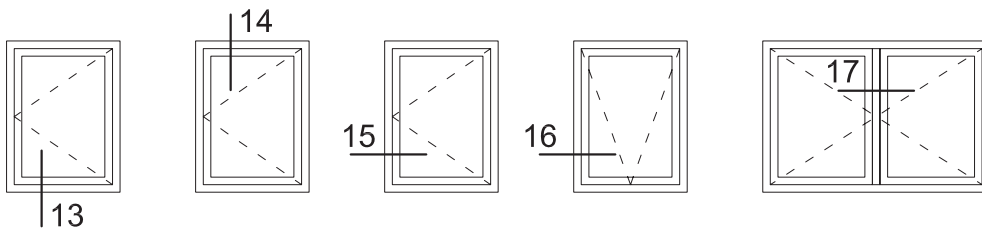

BALCONERAS

Ap. Interior

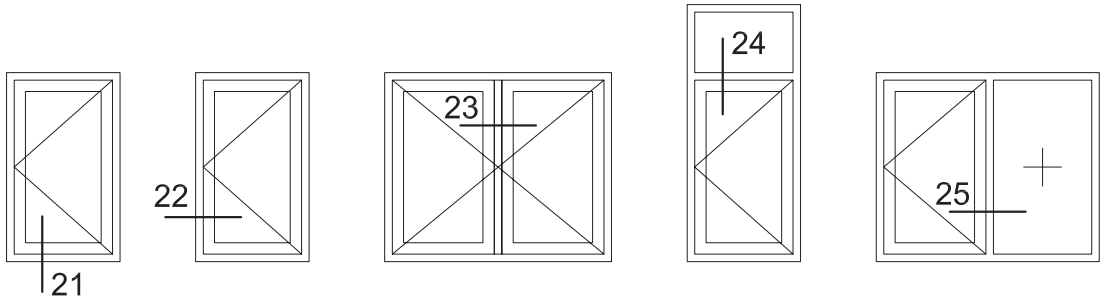

Oscilo Paralelas

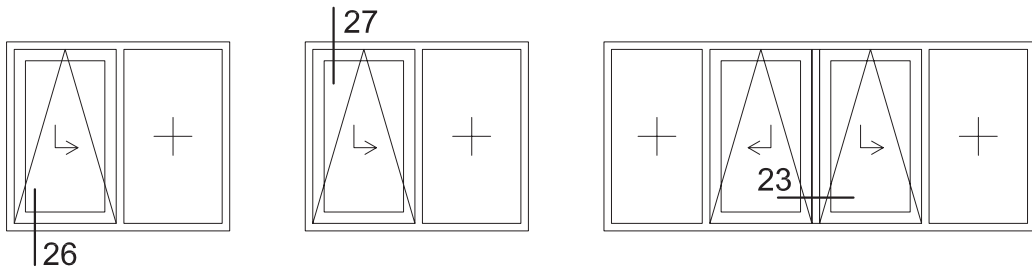

Plegables

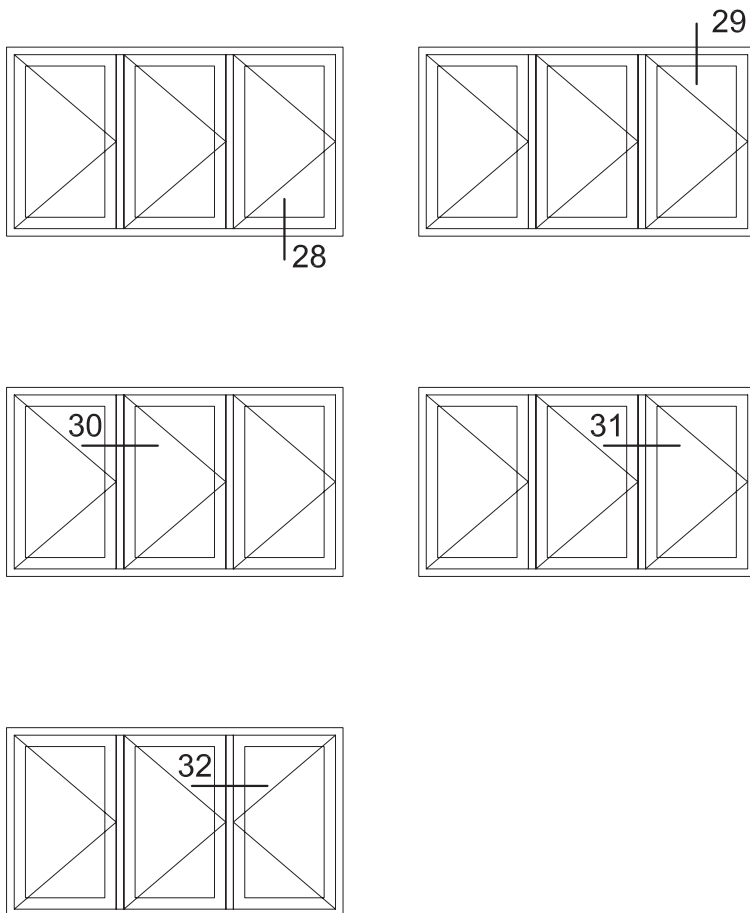

PUERTAS

Ap. Interior

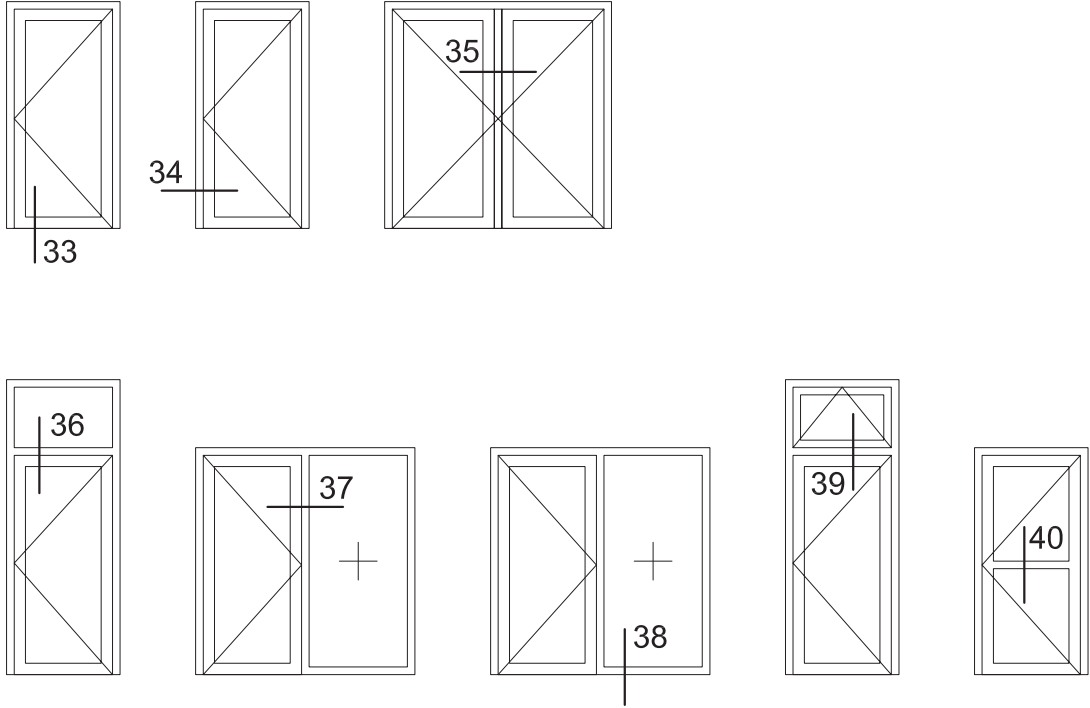

Ap. Exterior

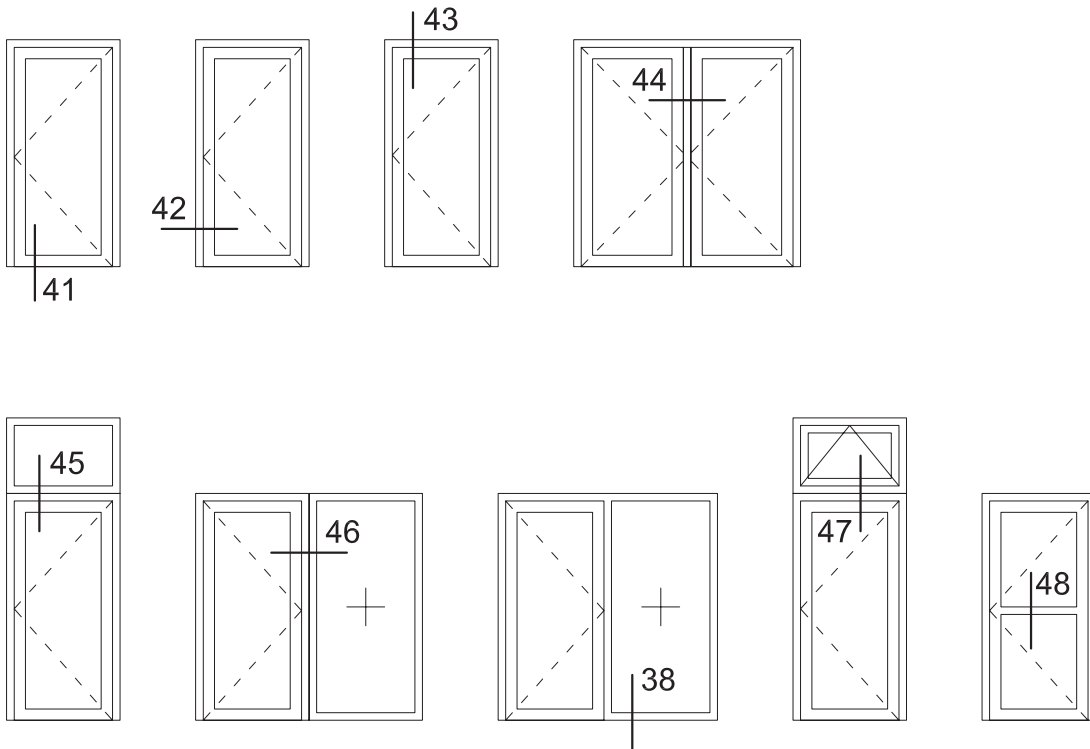

E 1:1

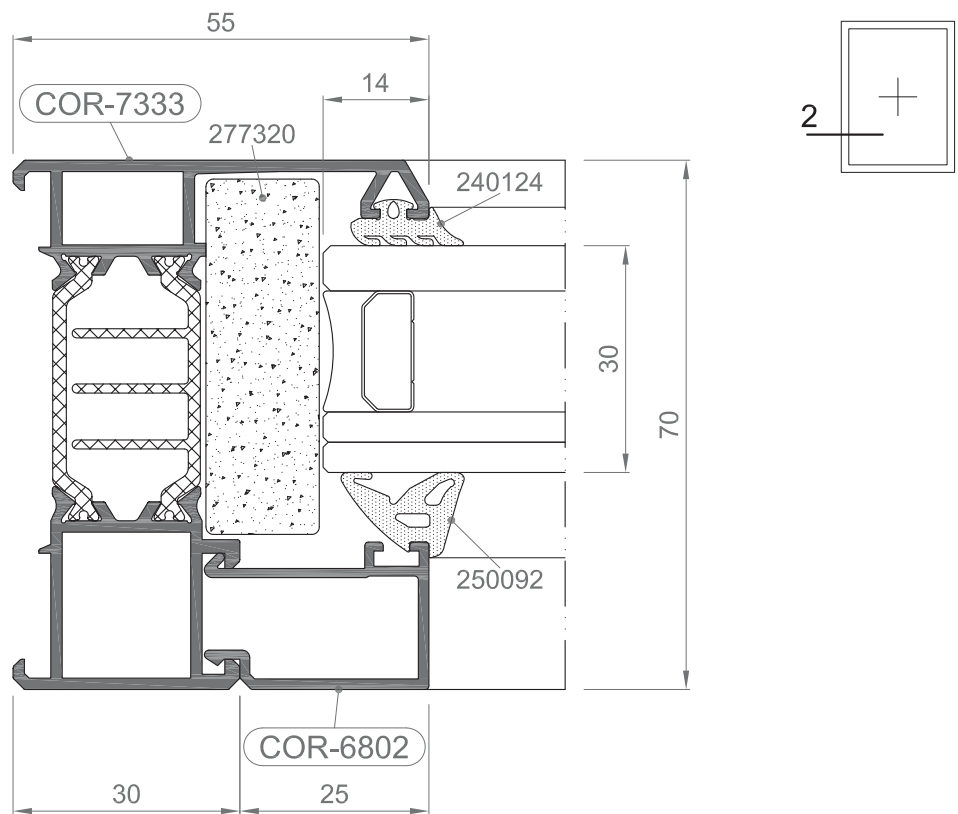
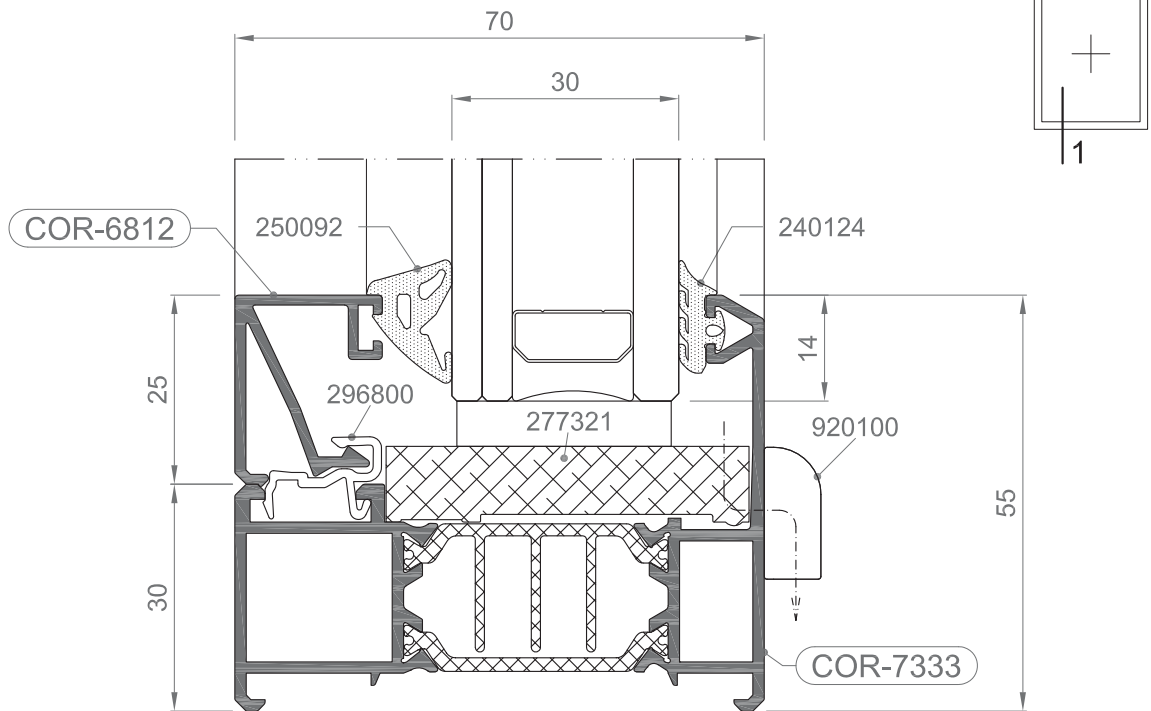

E 1:1

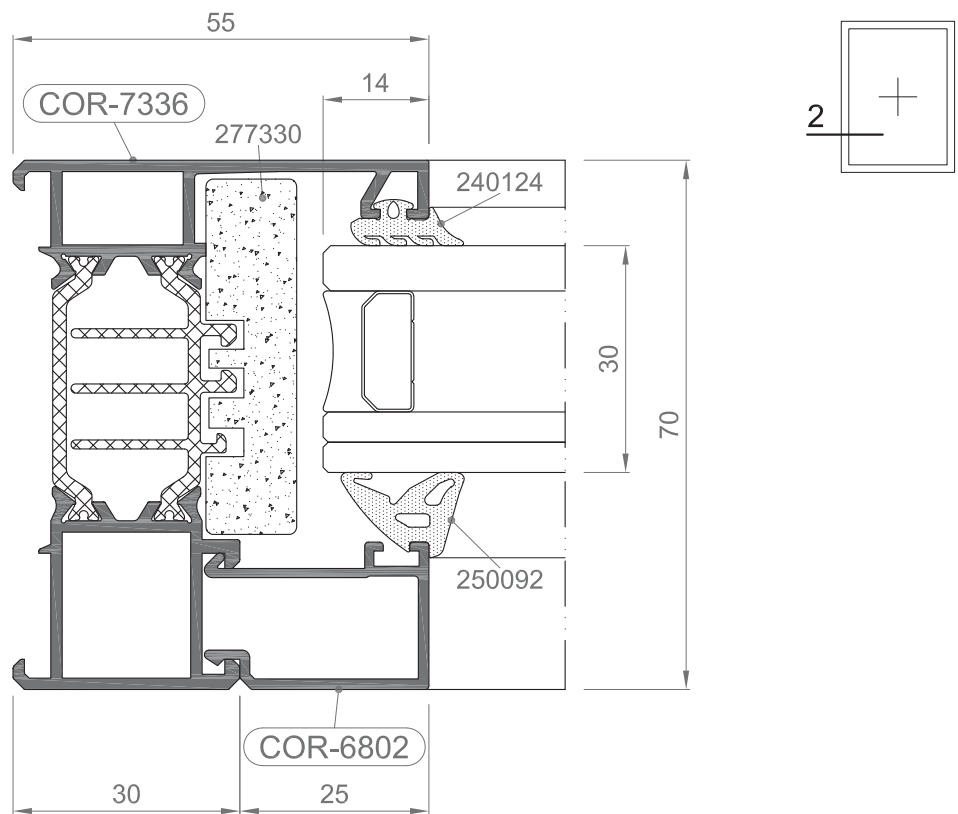
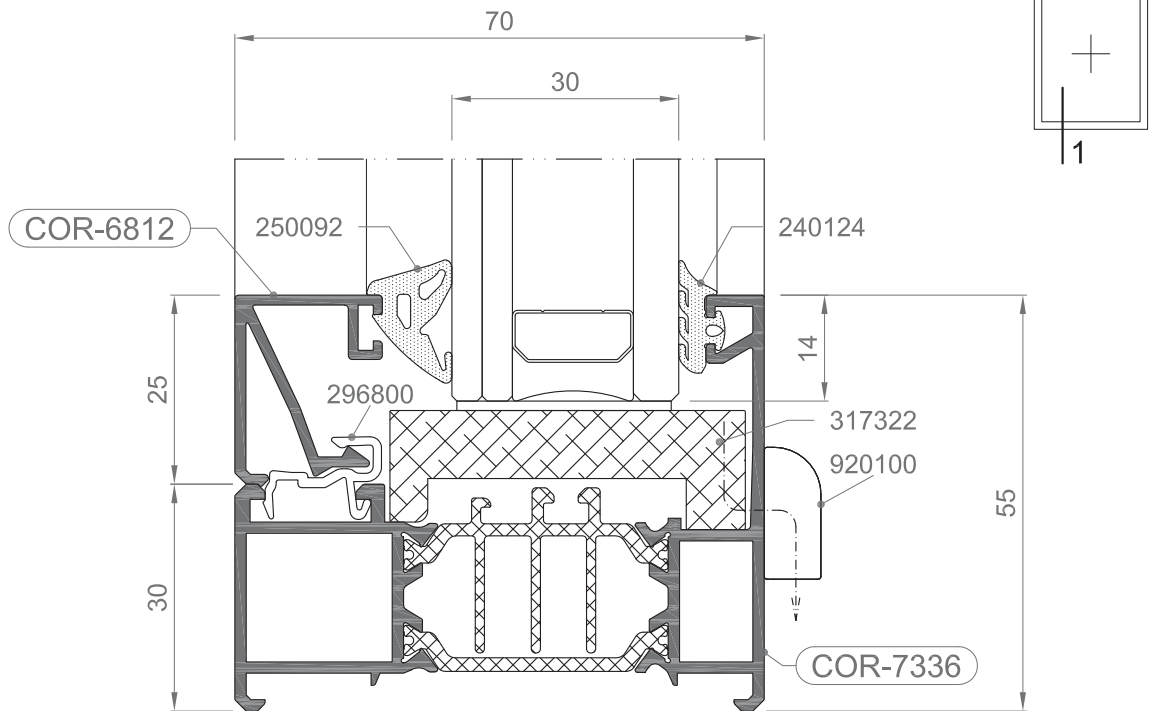

E 1:1

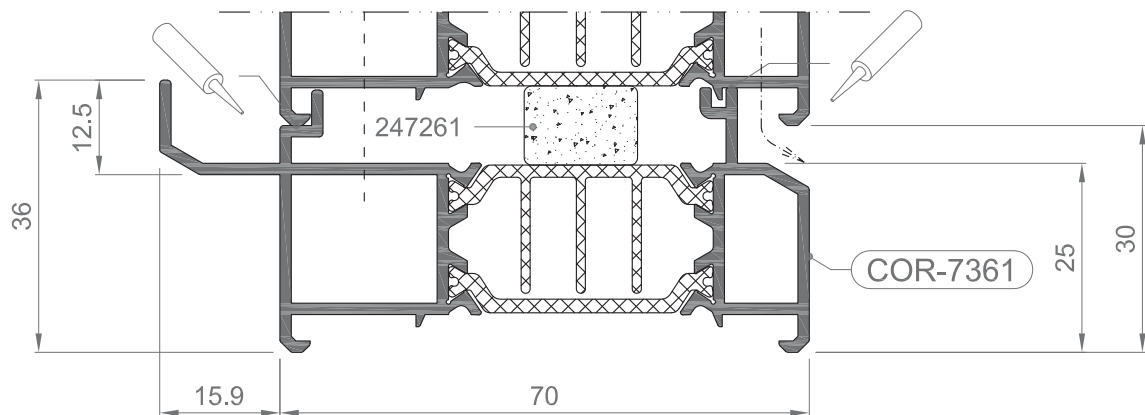
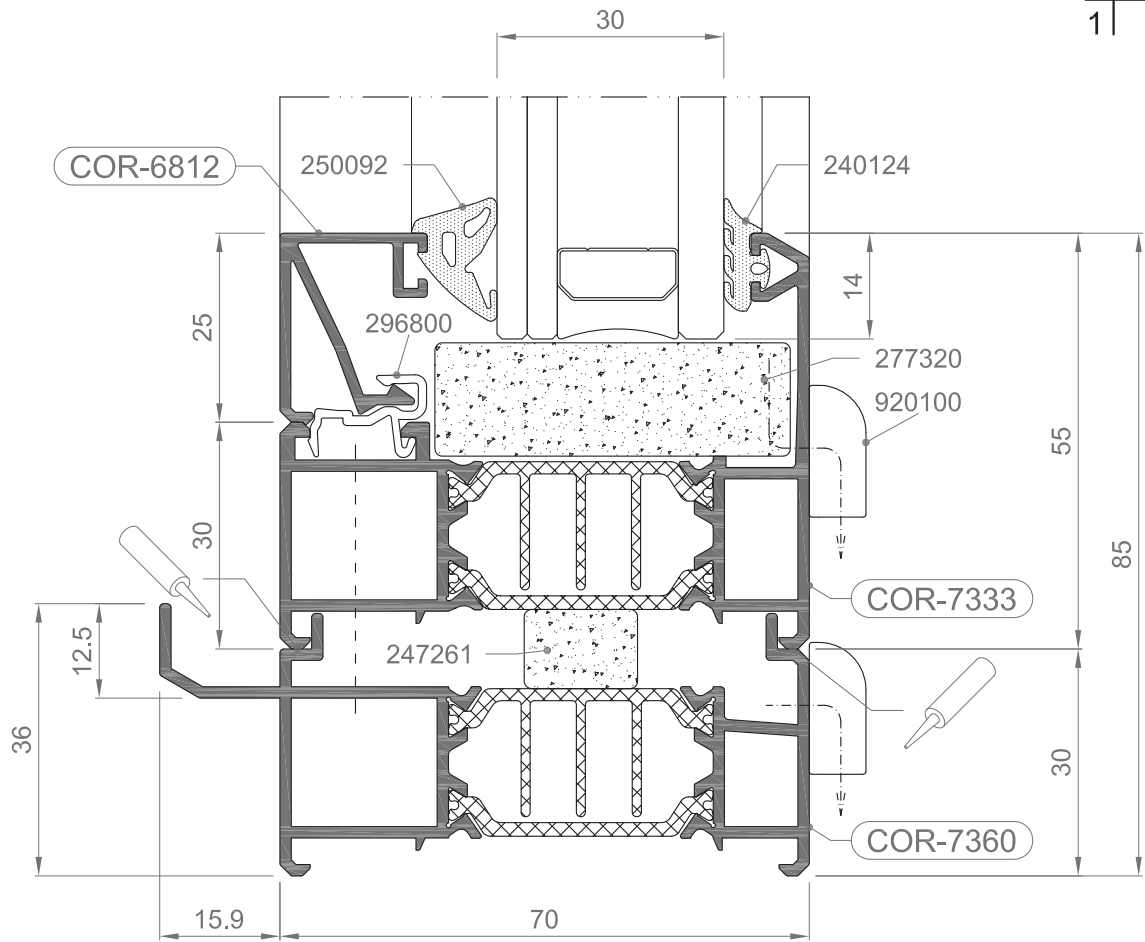
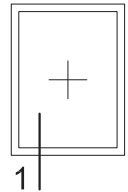

COR 70 CC16

Nudos constructivos

E 1:1

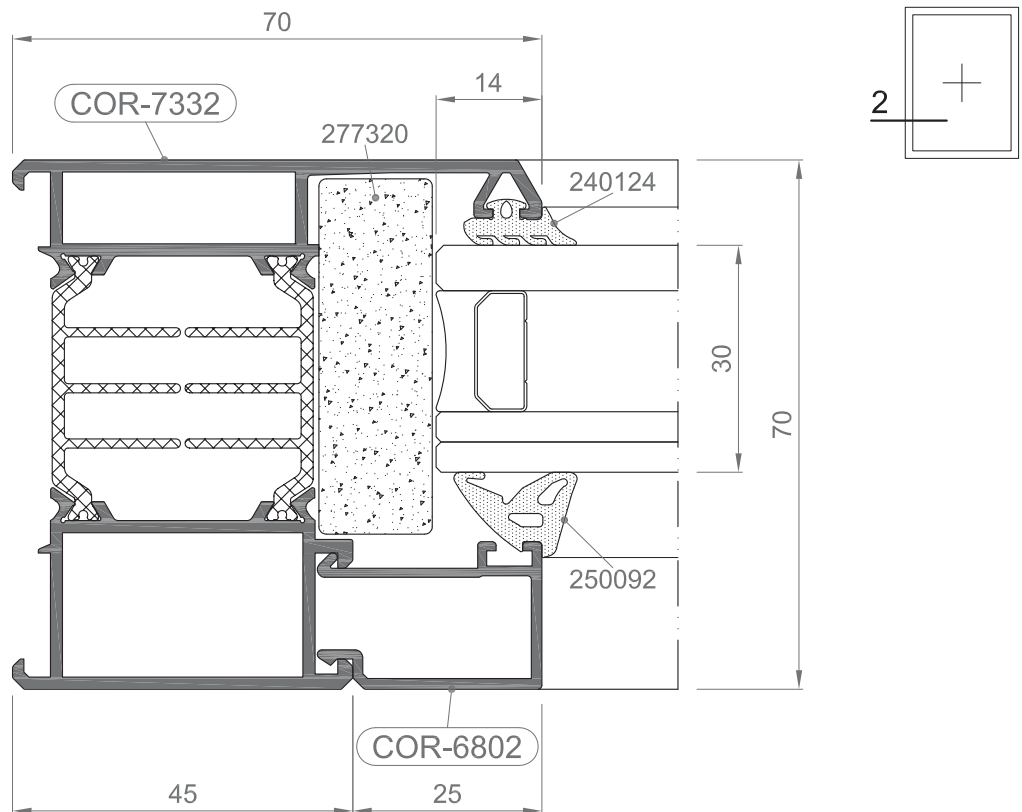
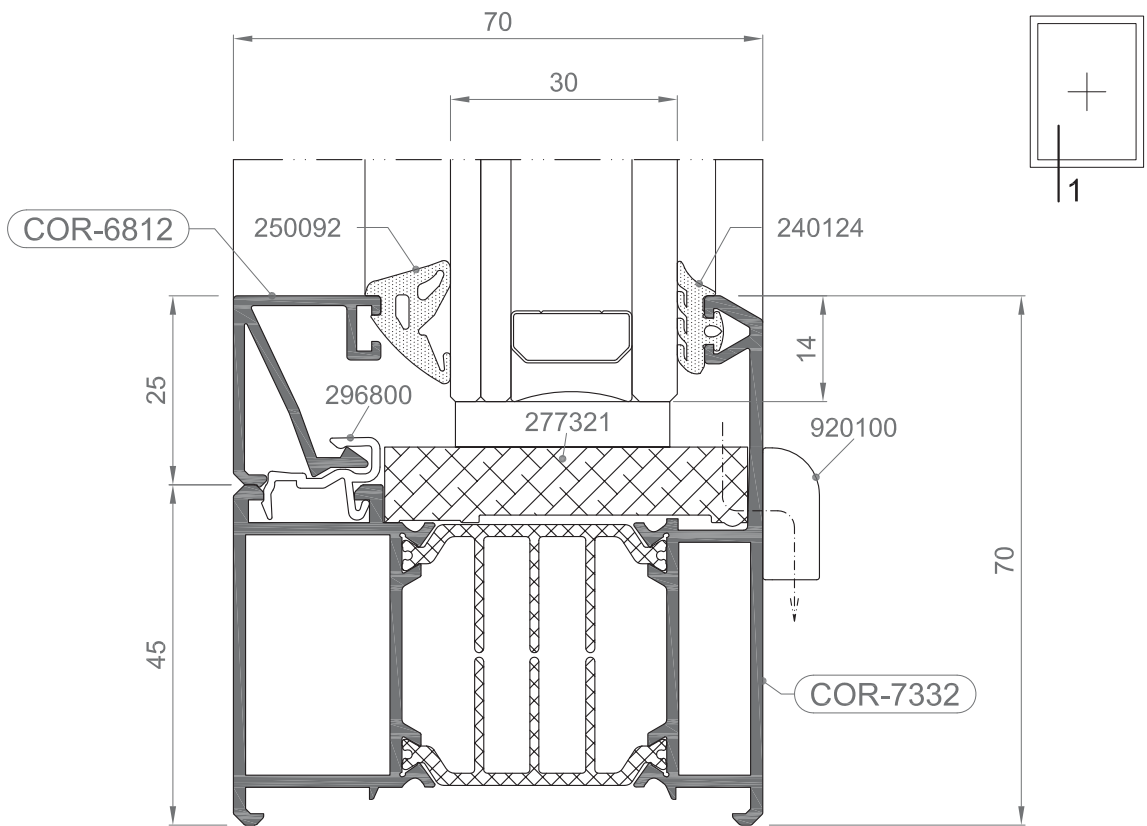

COR 70 CC16

Nudos constructivos

E 1:1

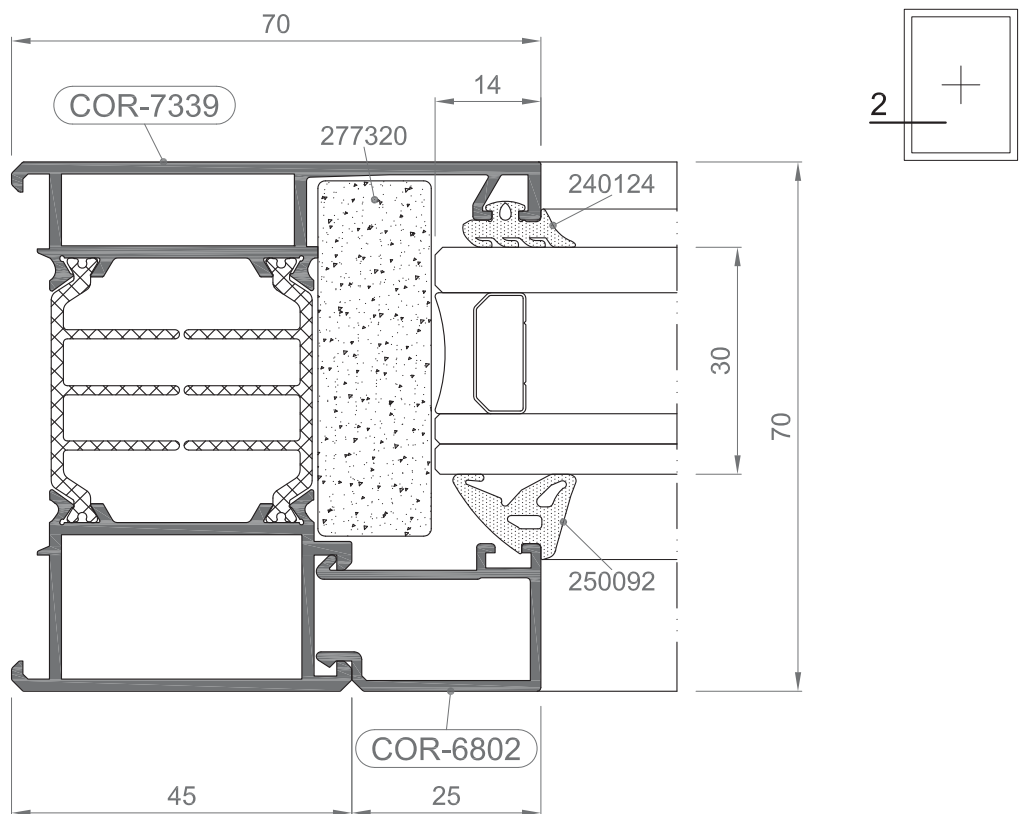
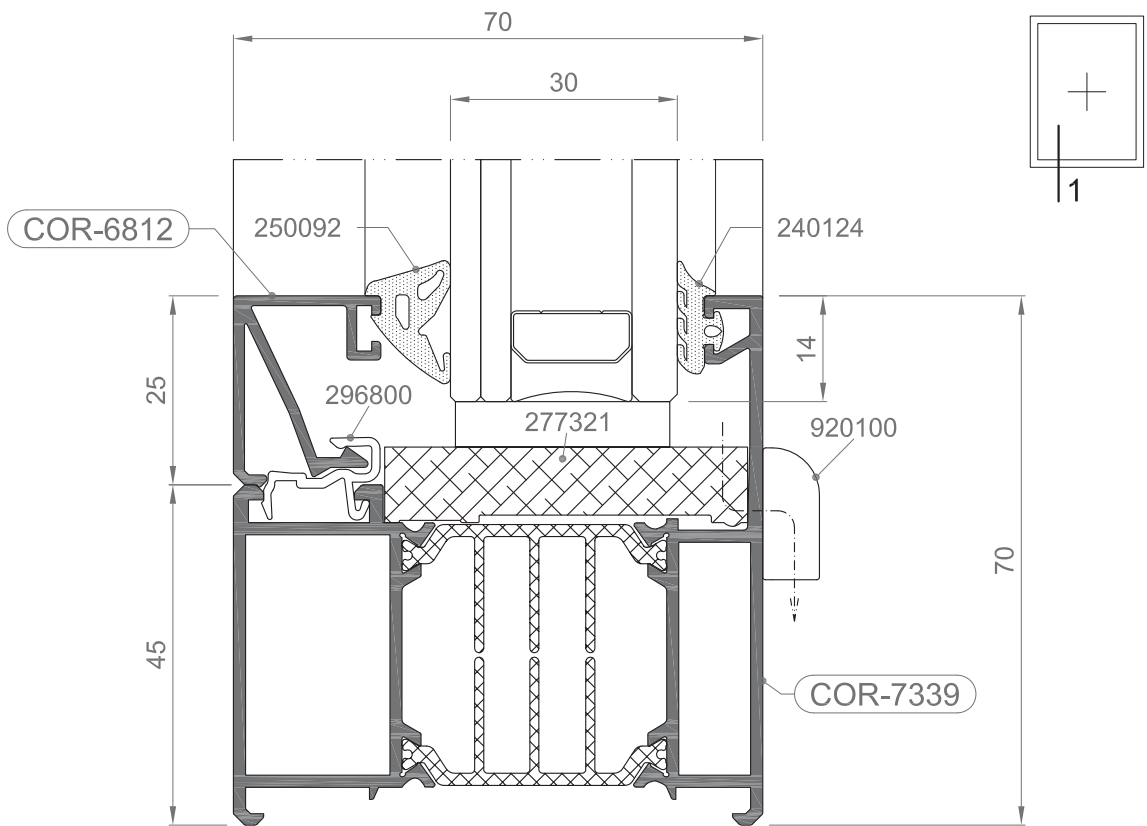

COR 70 CC16

Nudos constructivos

E 1:1

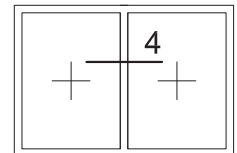
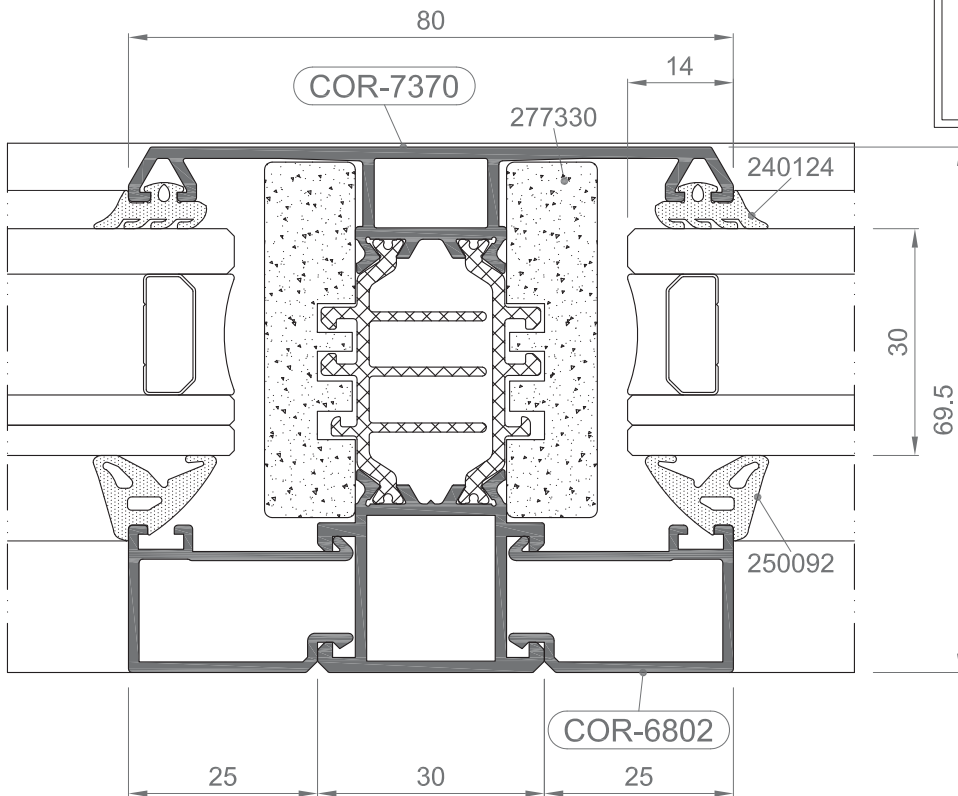
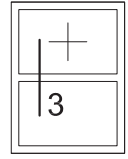
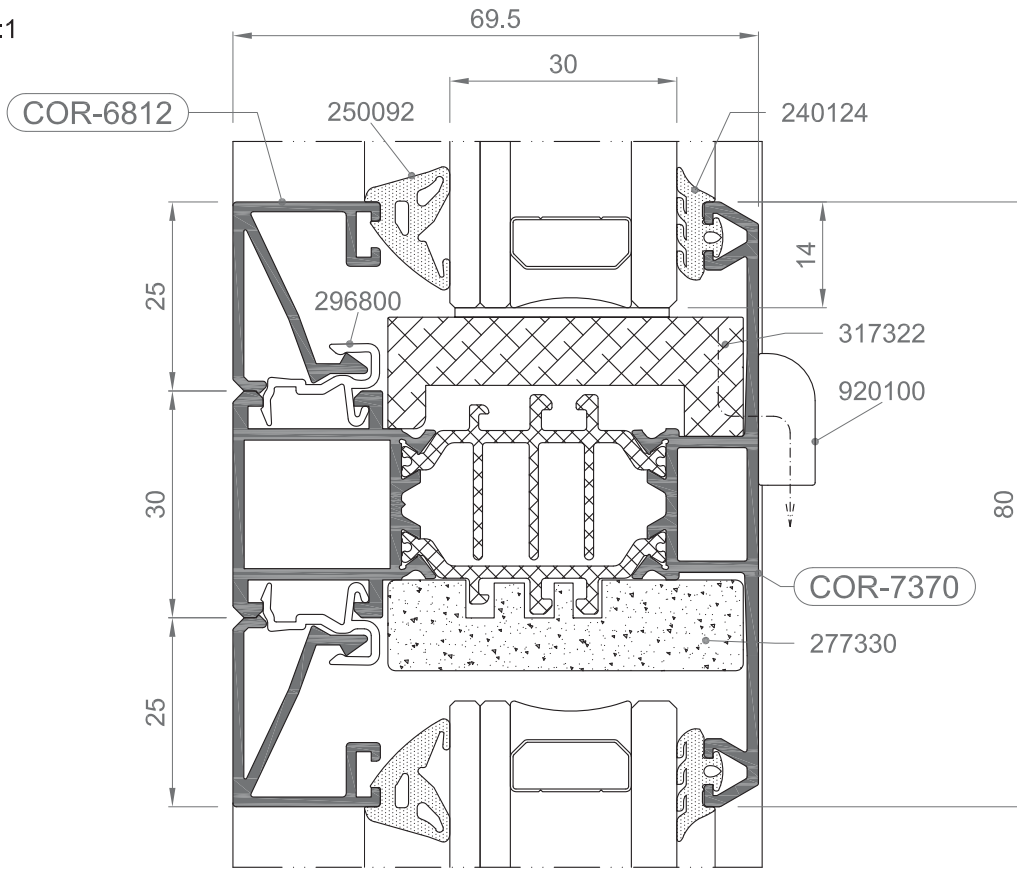

COR 70 CC16

Nudos constructivos

E 1:1

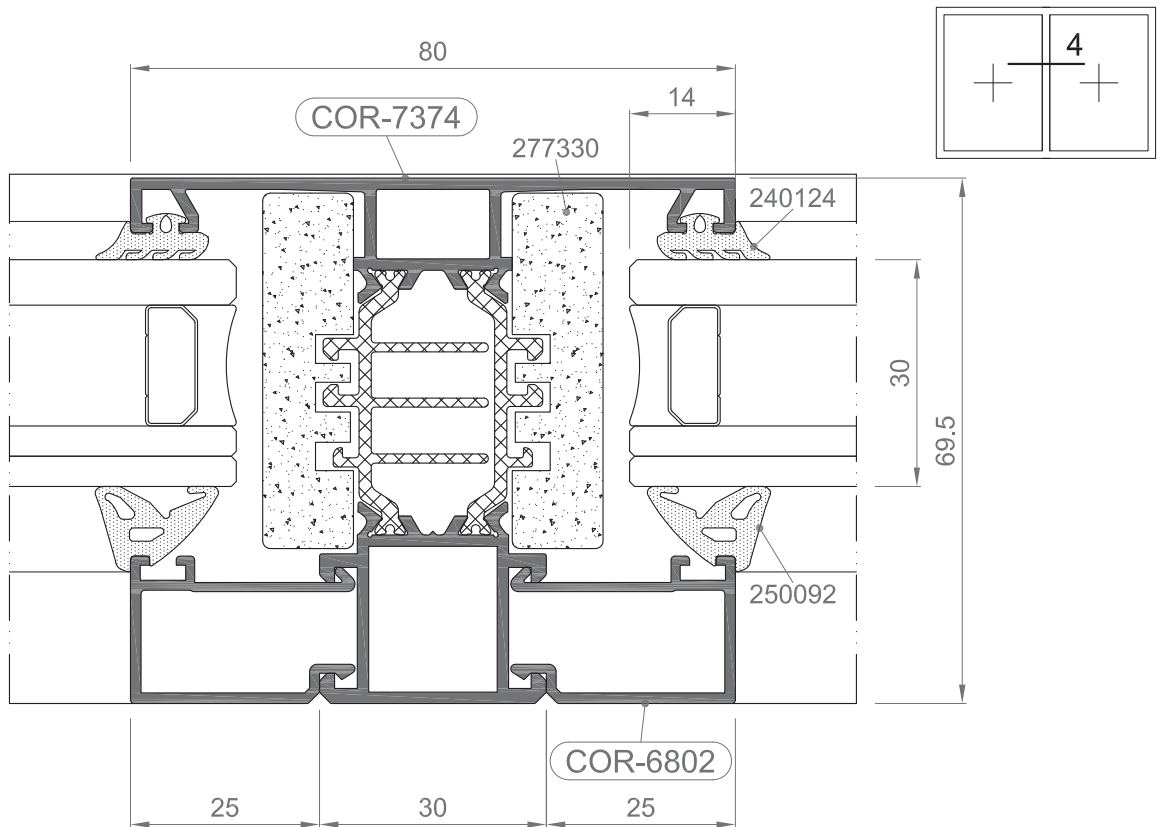
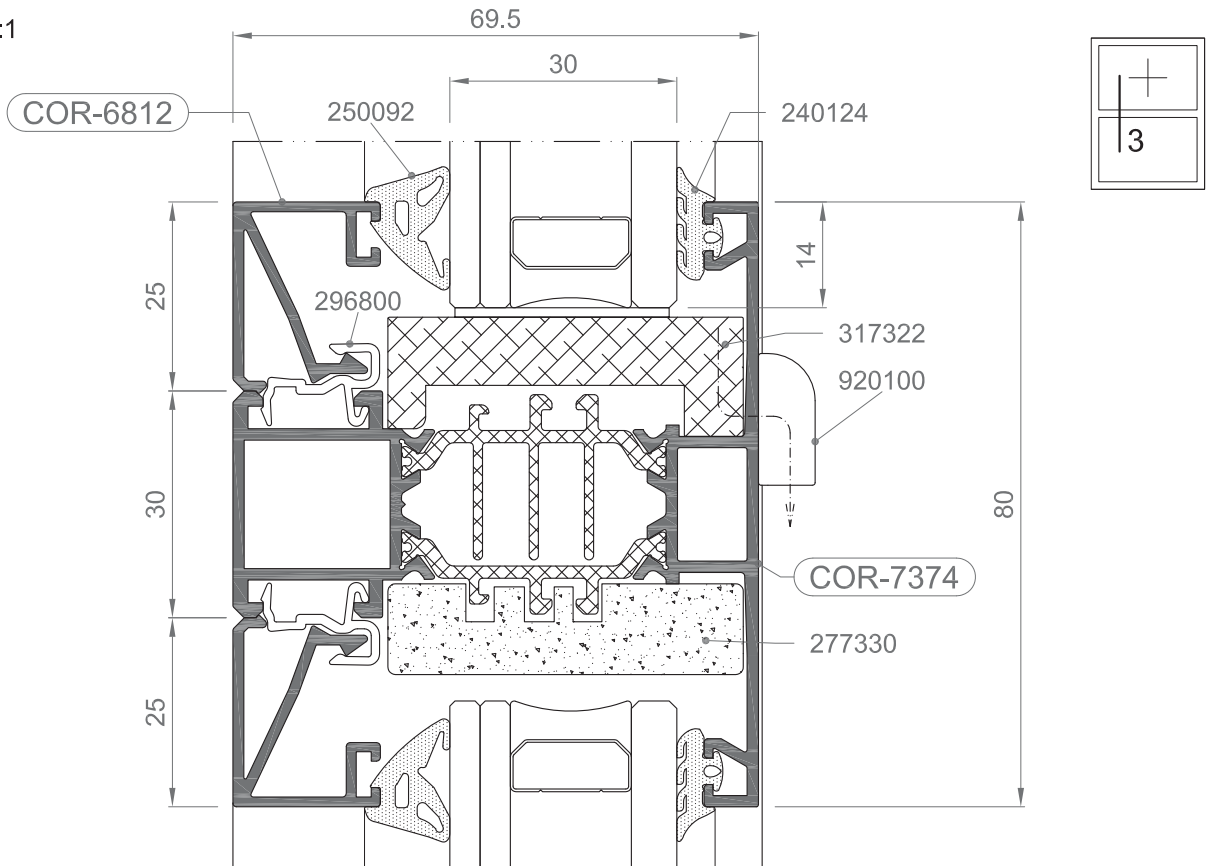

COR 70 CC16

Nudos constructivos

E 1:1

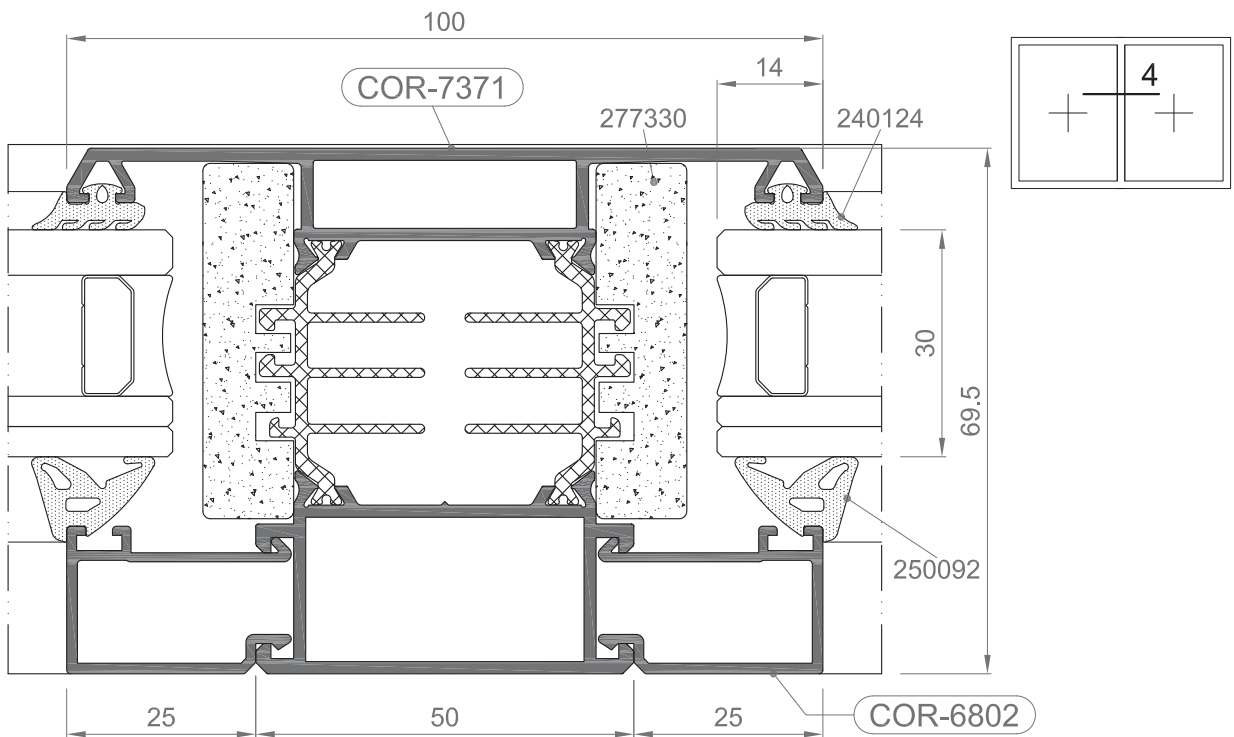
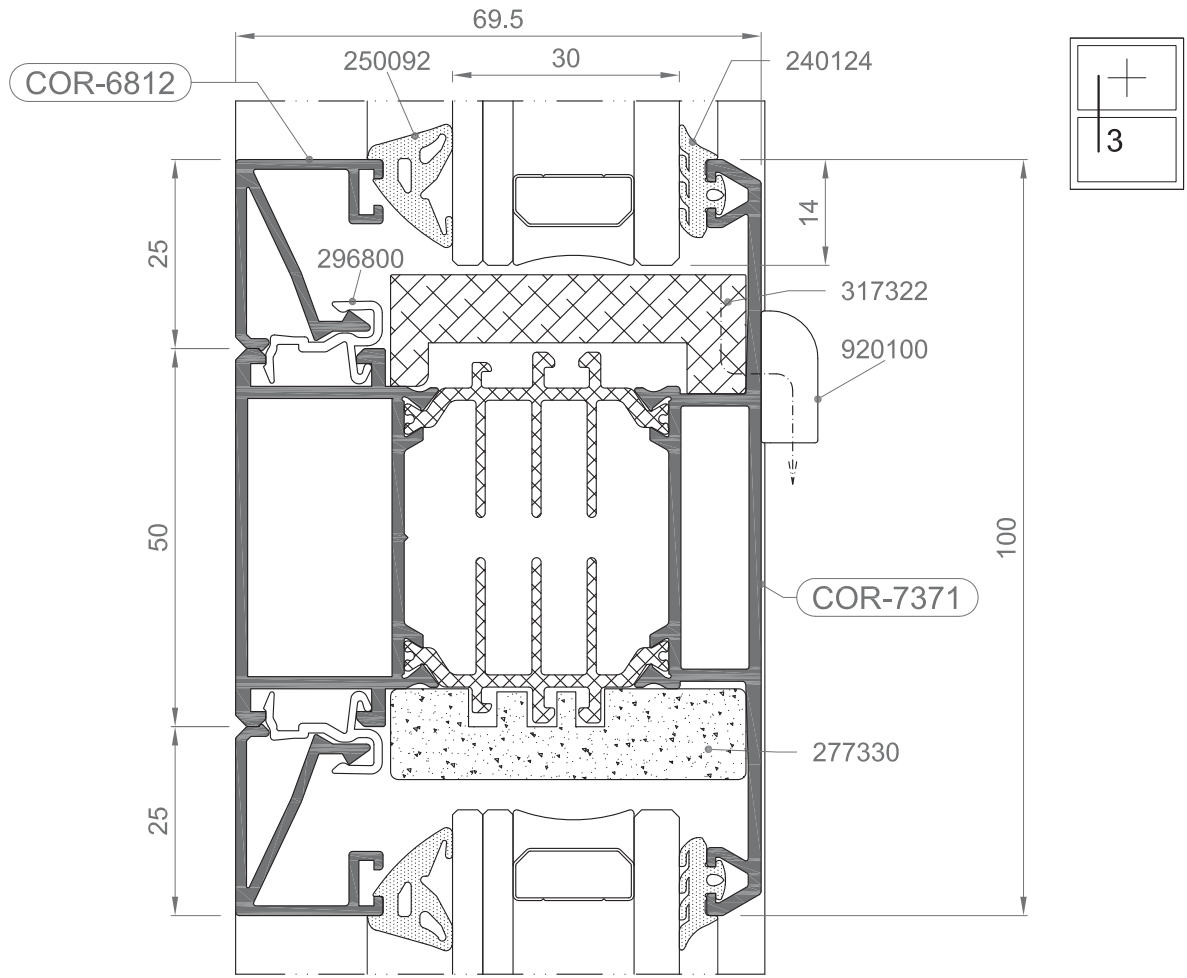

E 1:1

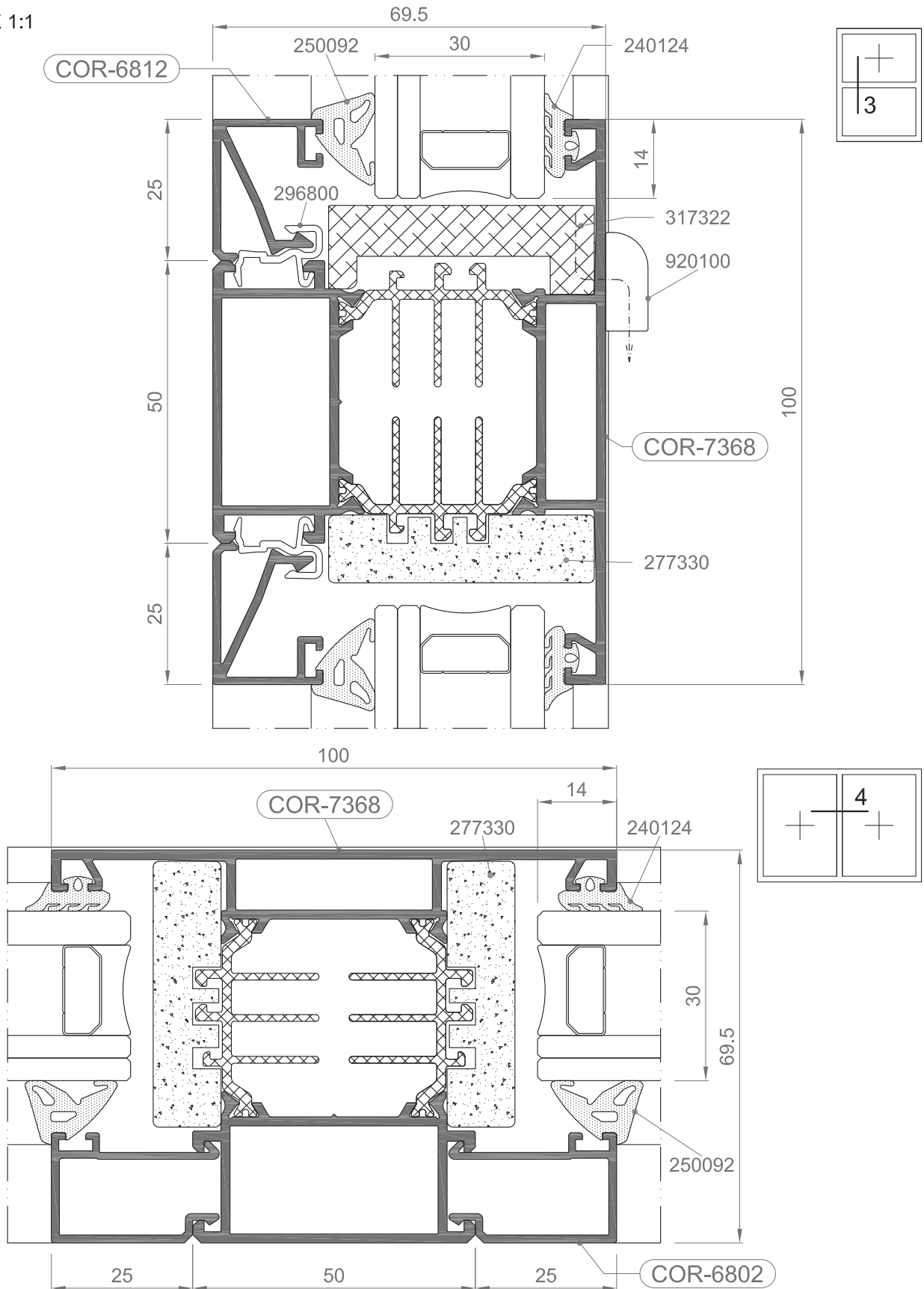

E 1:1

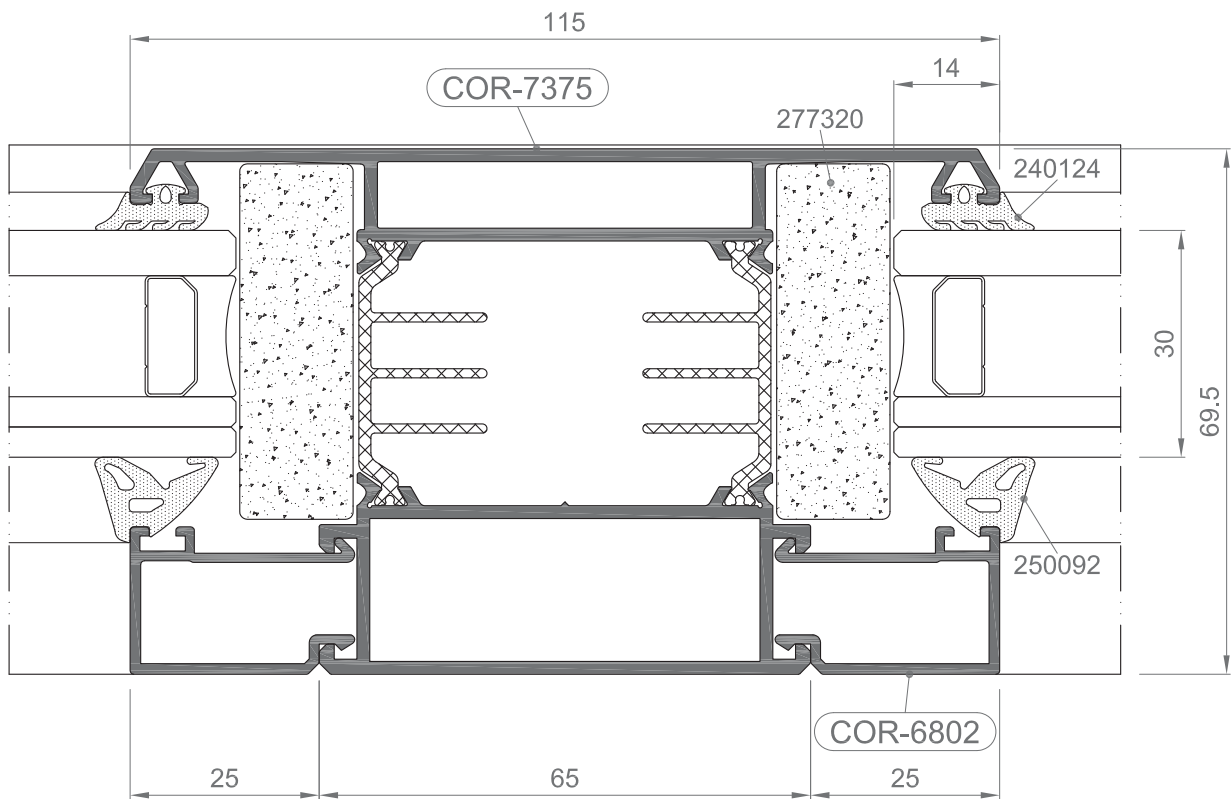
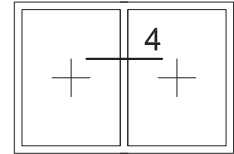

COR 70 CC16

Nudos constructivos

E 1:1

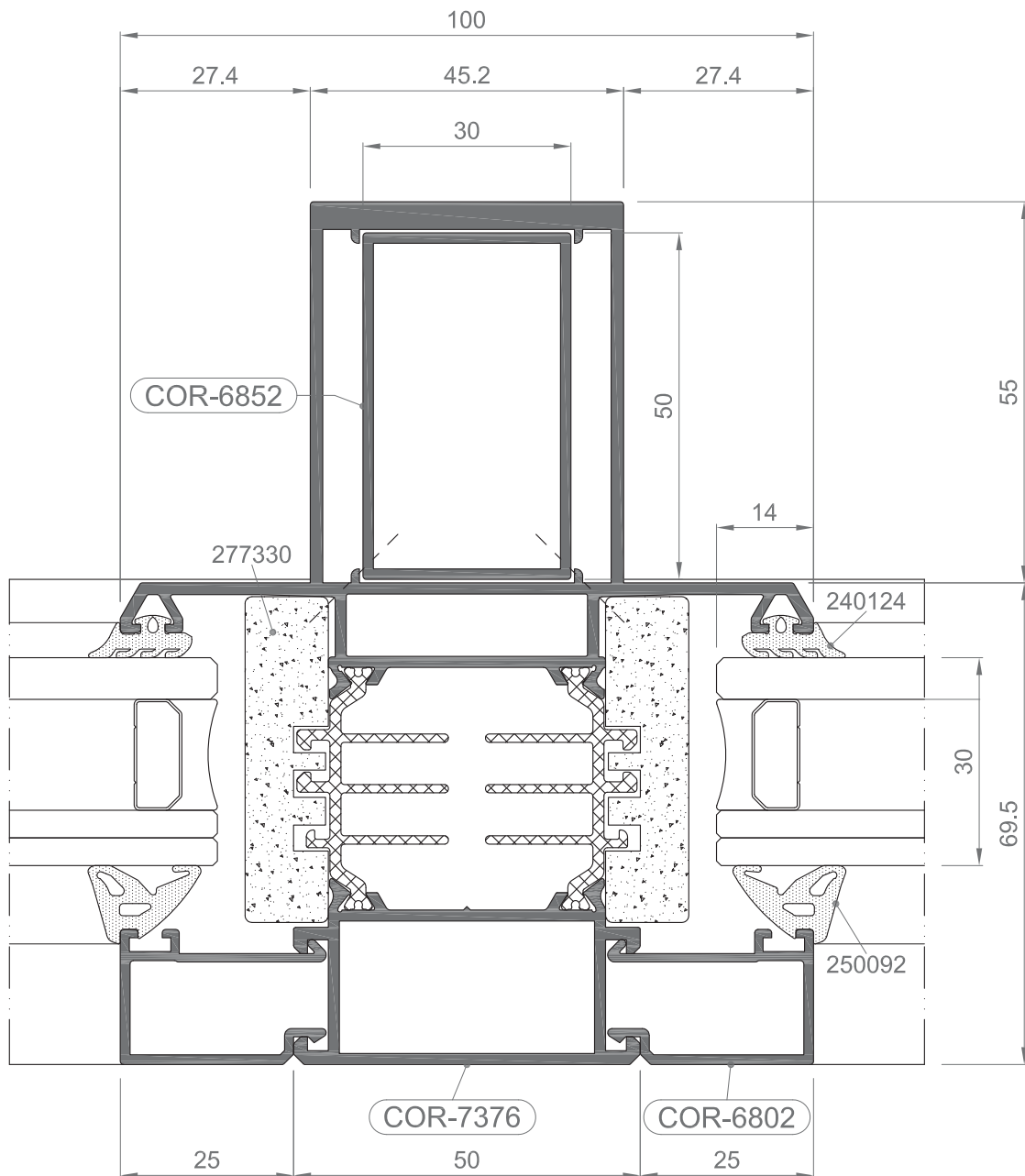
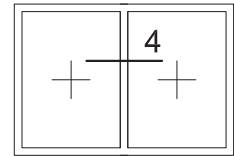

E 1:1

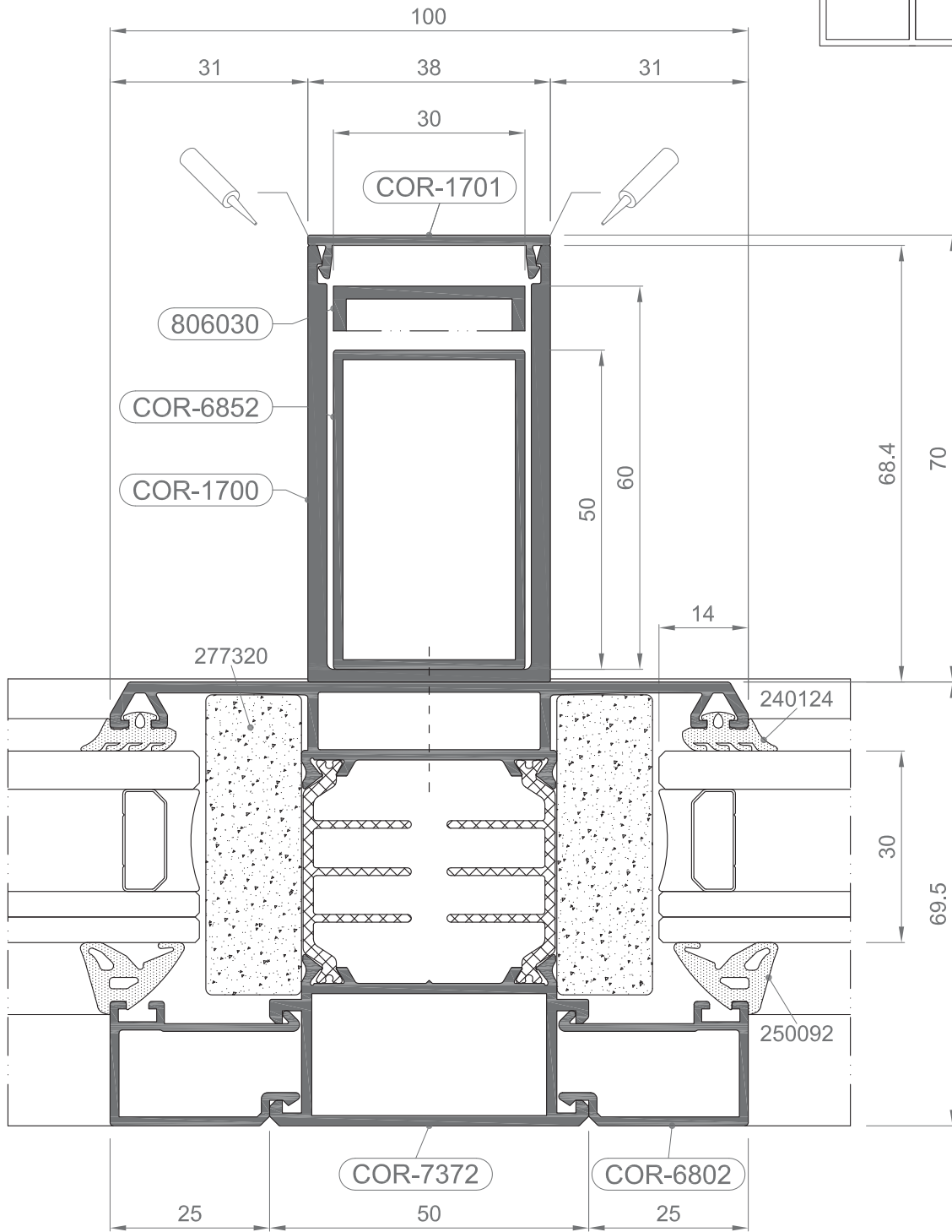
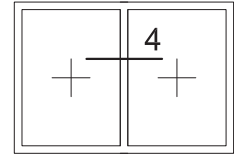

E 1:1

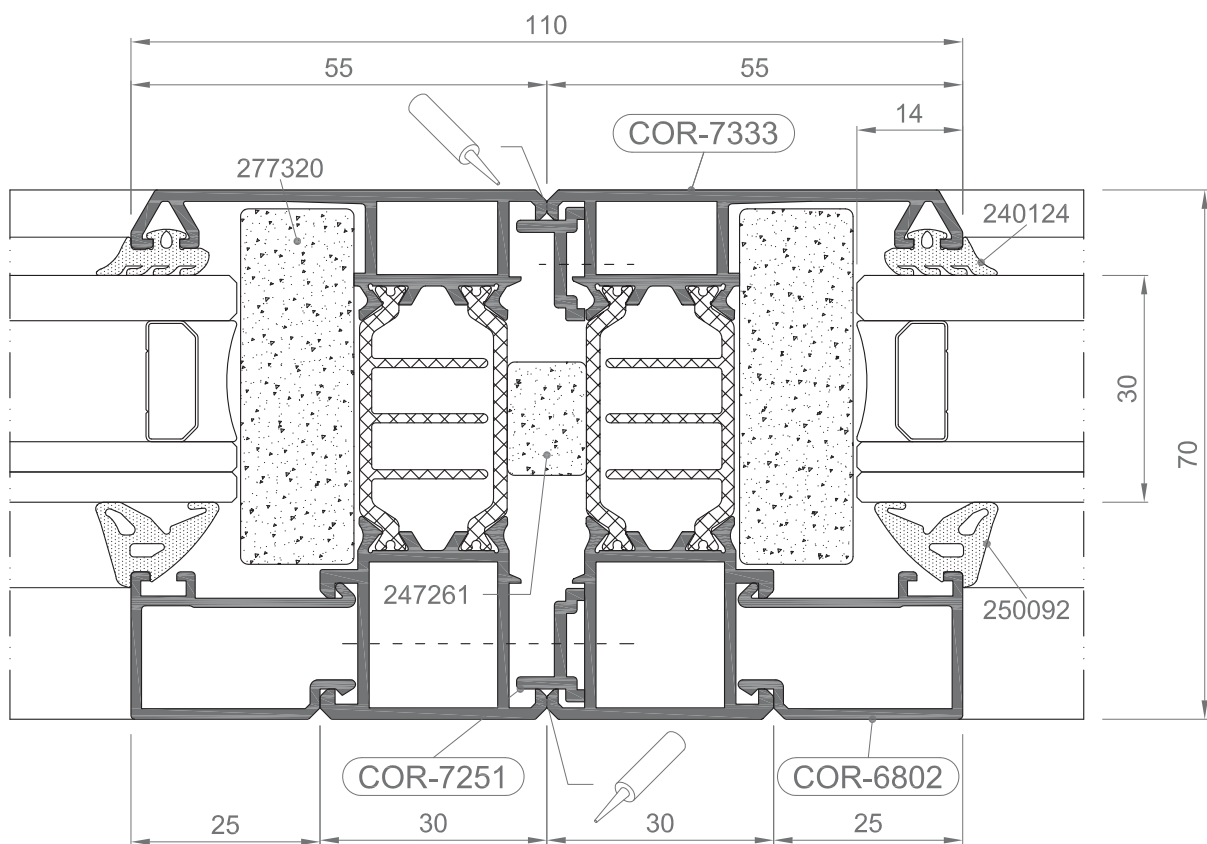
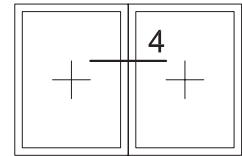

E 1:1

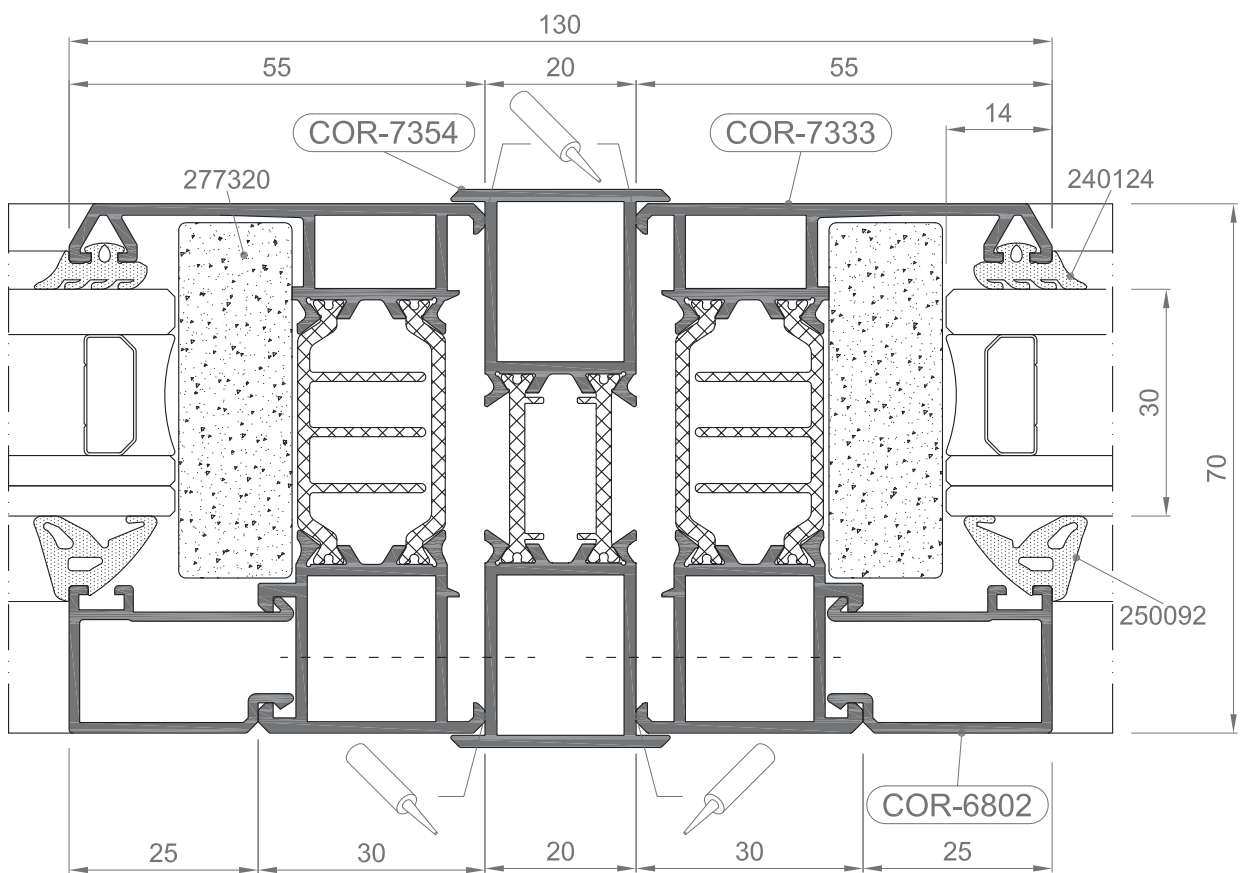
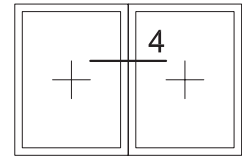

E 1:1

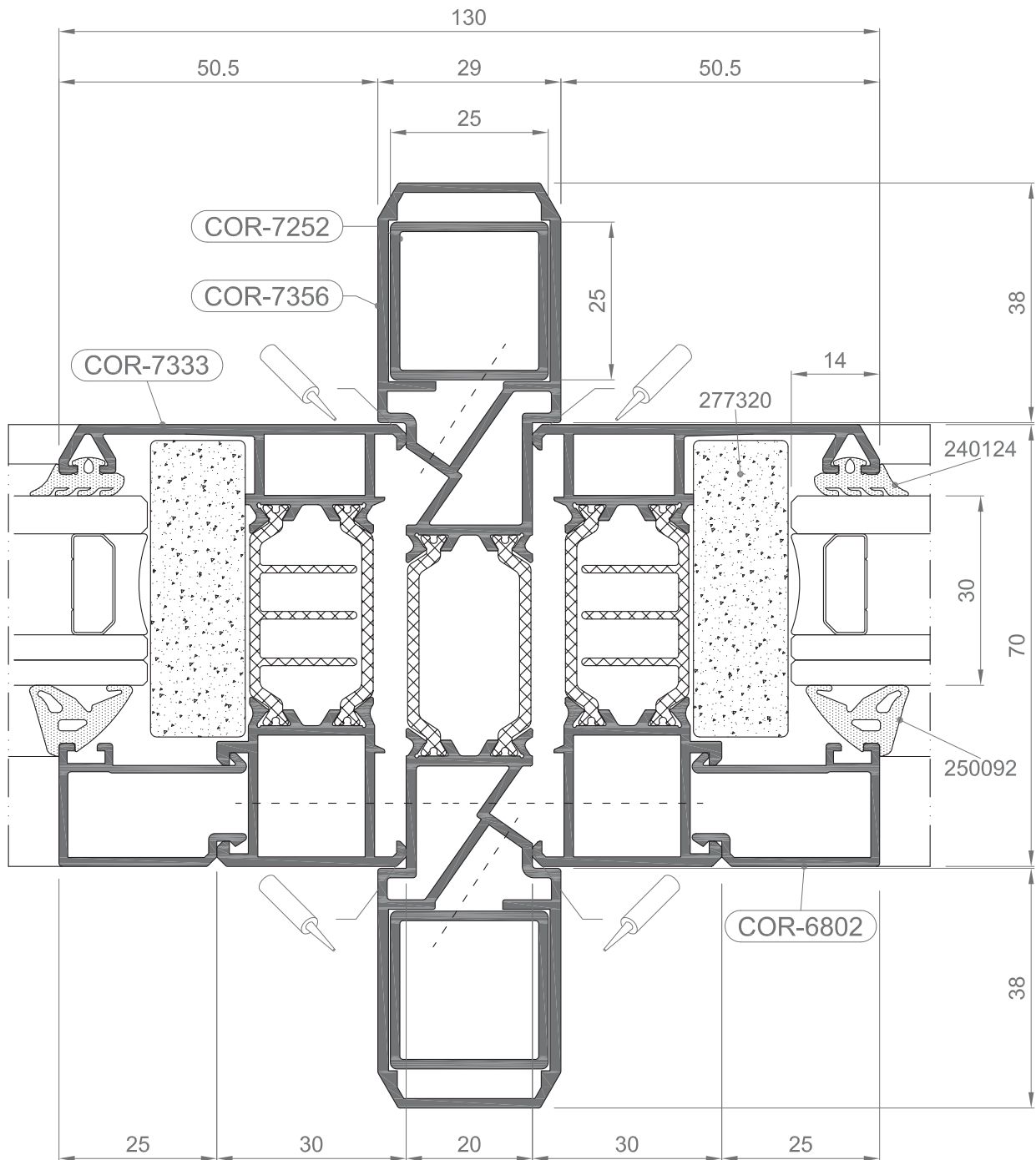
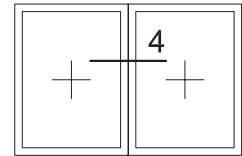

E 1:1

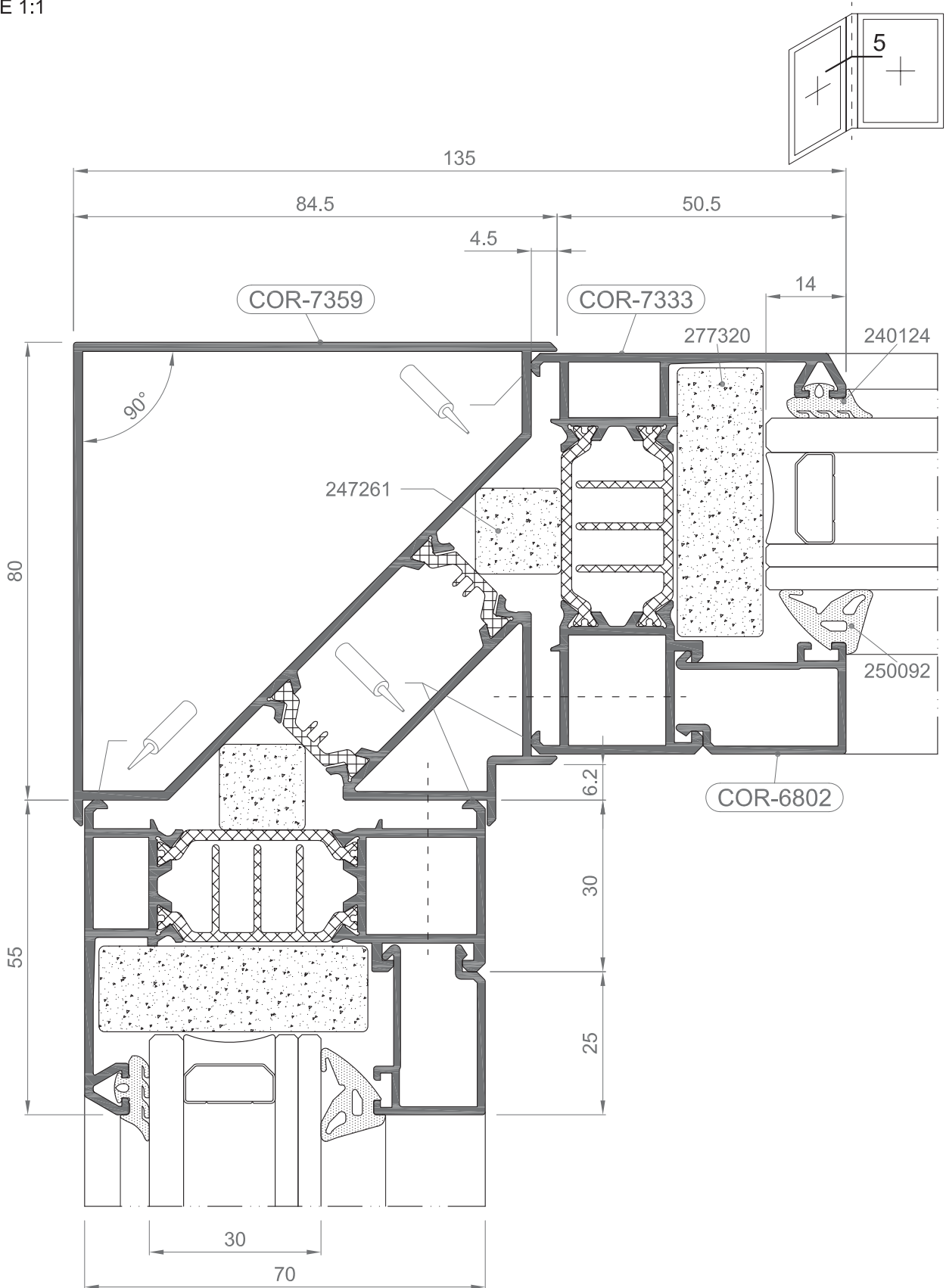

E 1:1

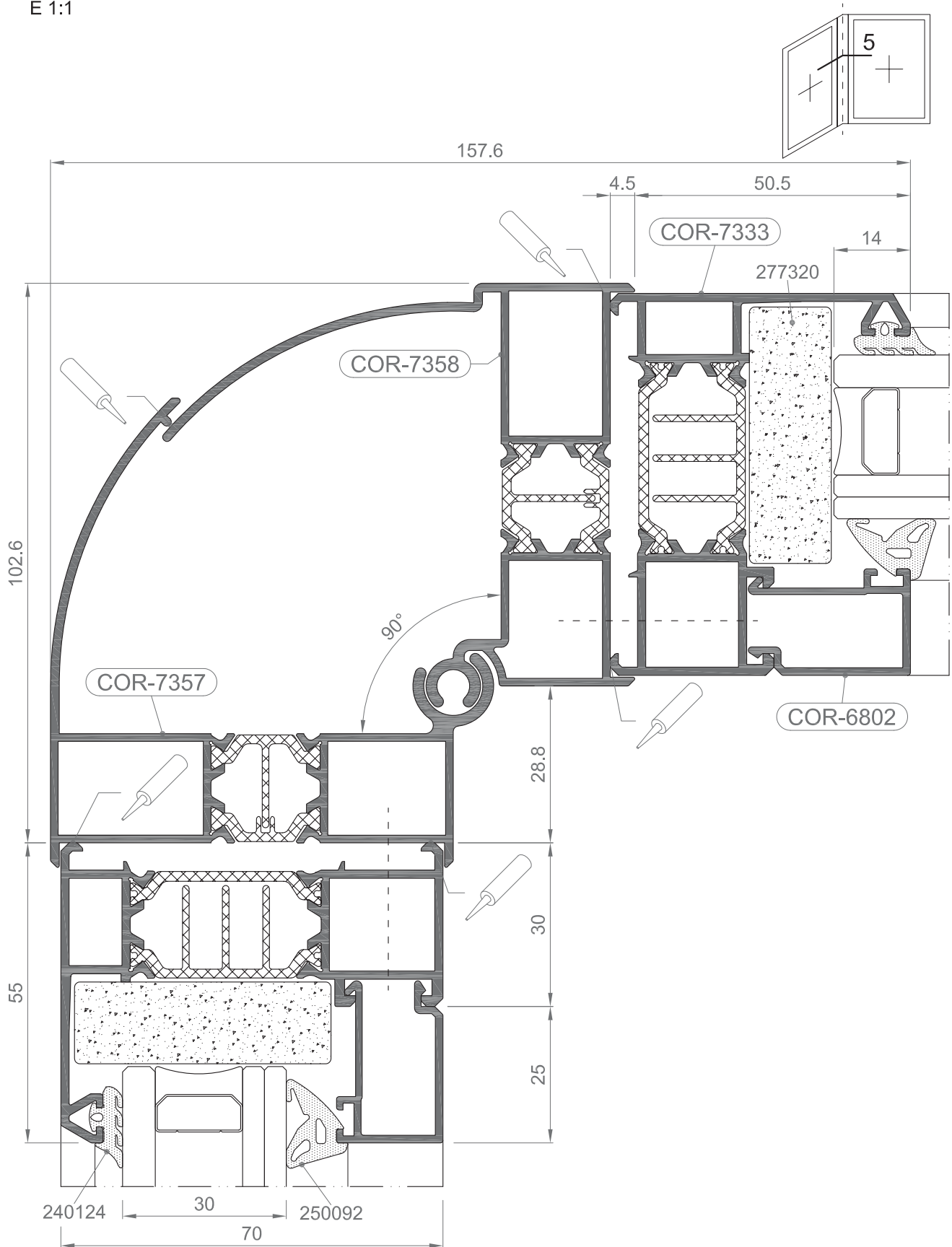

COR 70 CC16

Nudos constructivos

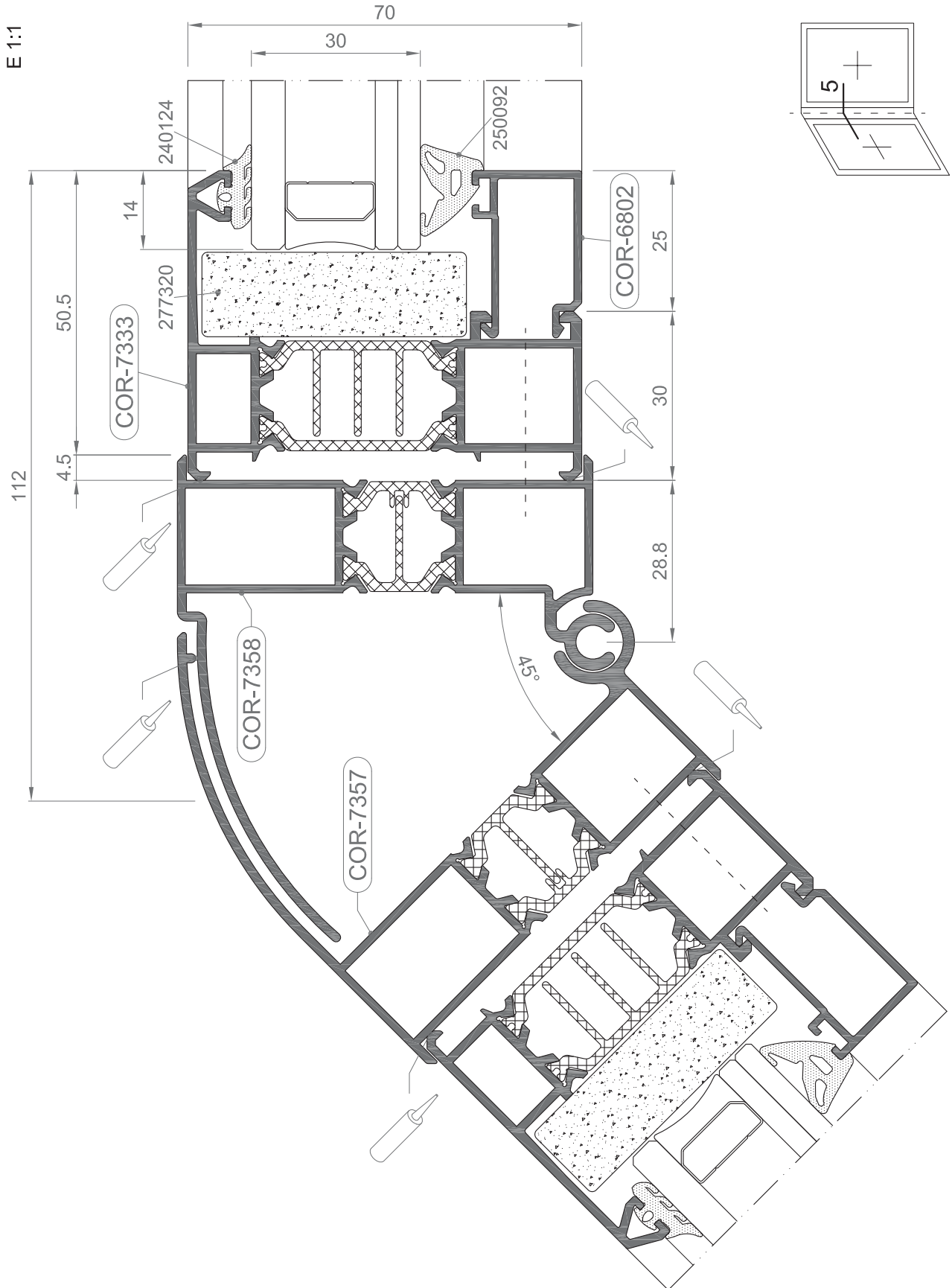

E 1:1

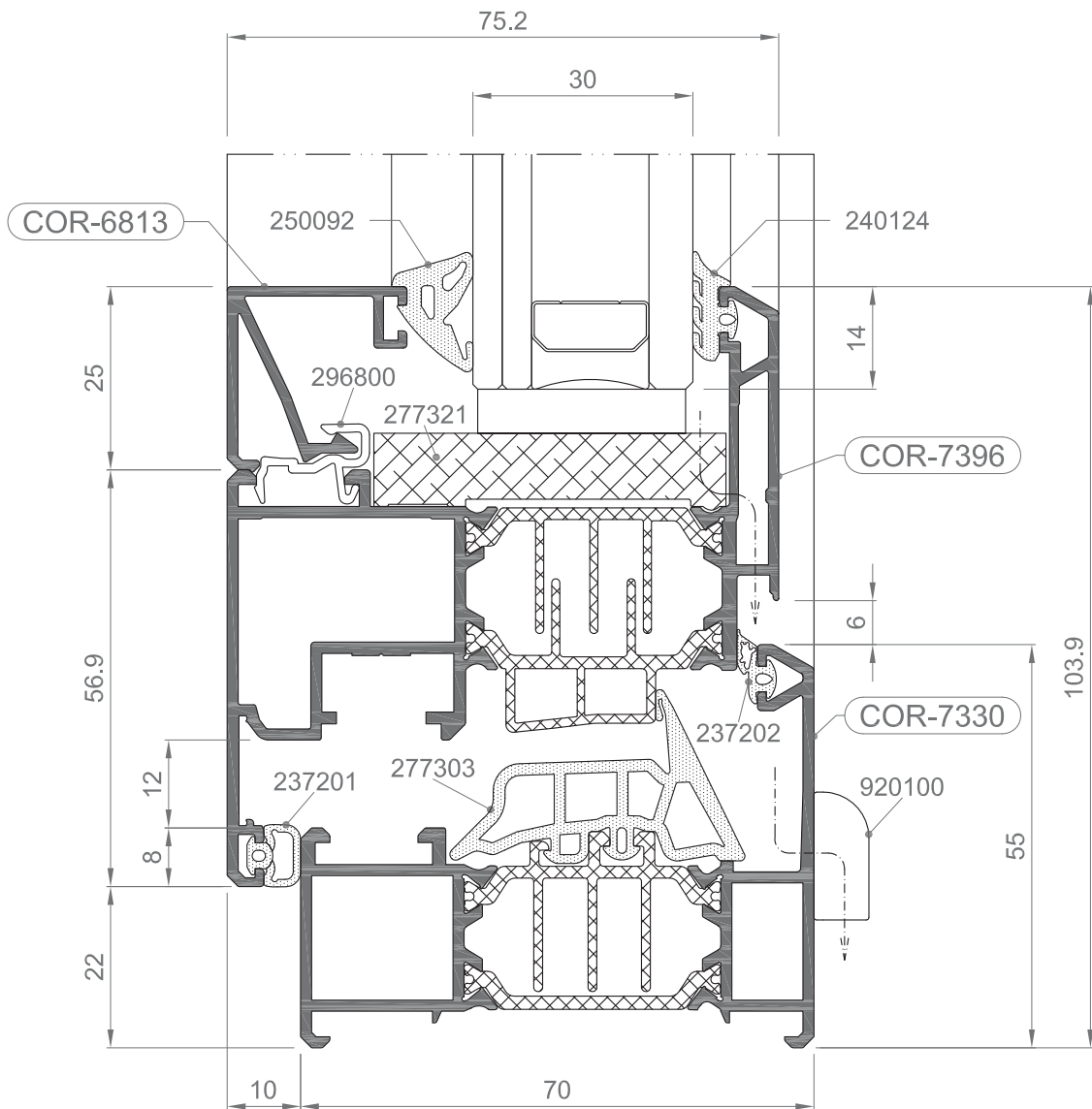
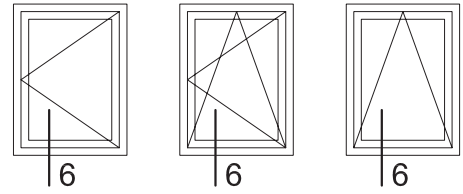

E 1:1

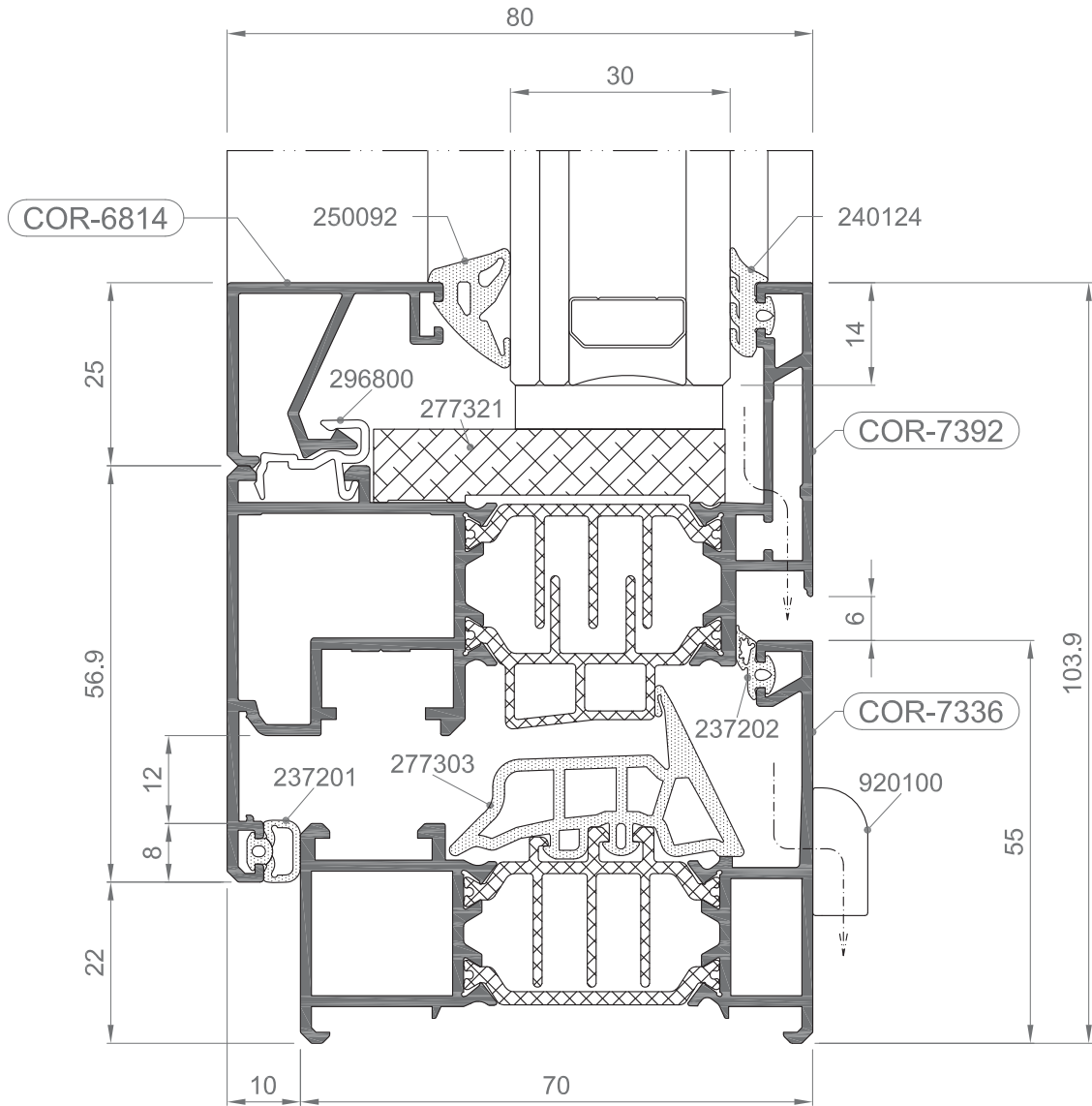
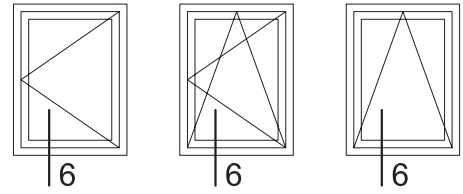

E 1:1

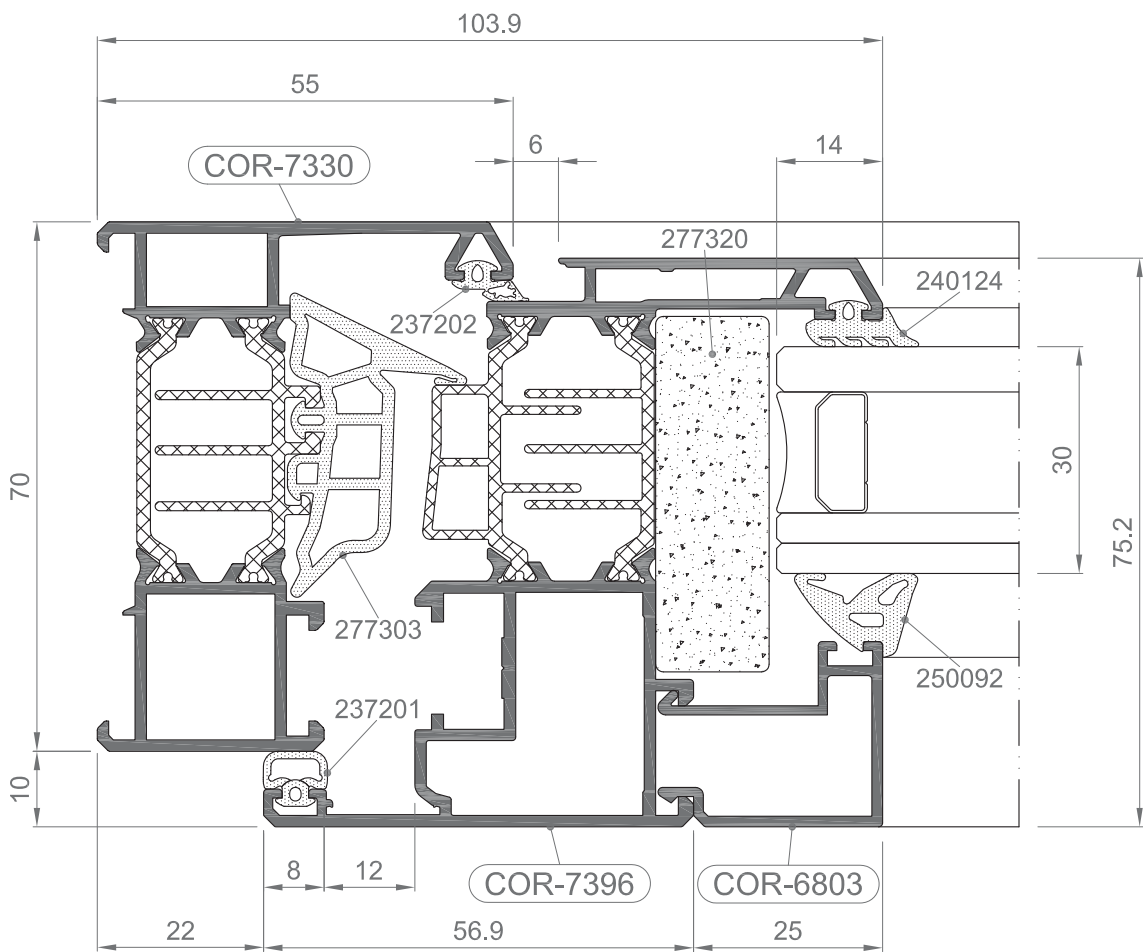
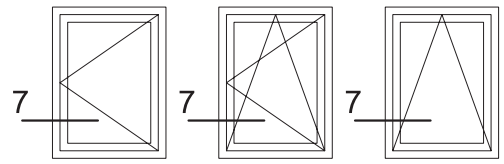

E 1:1

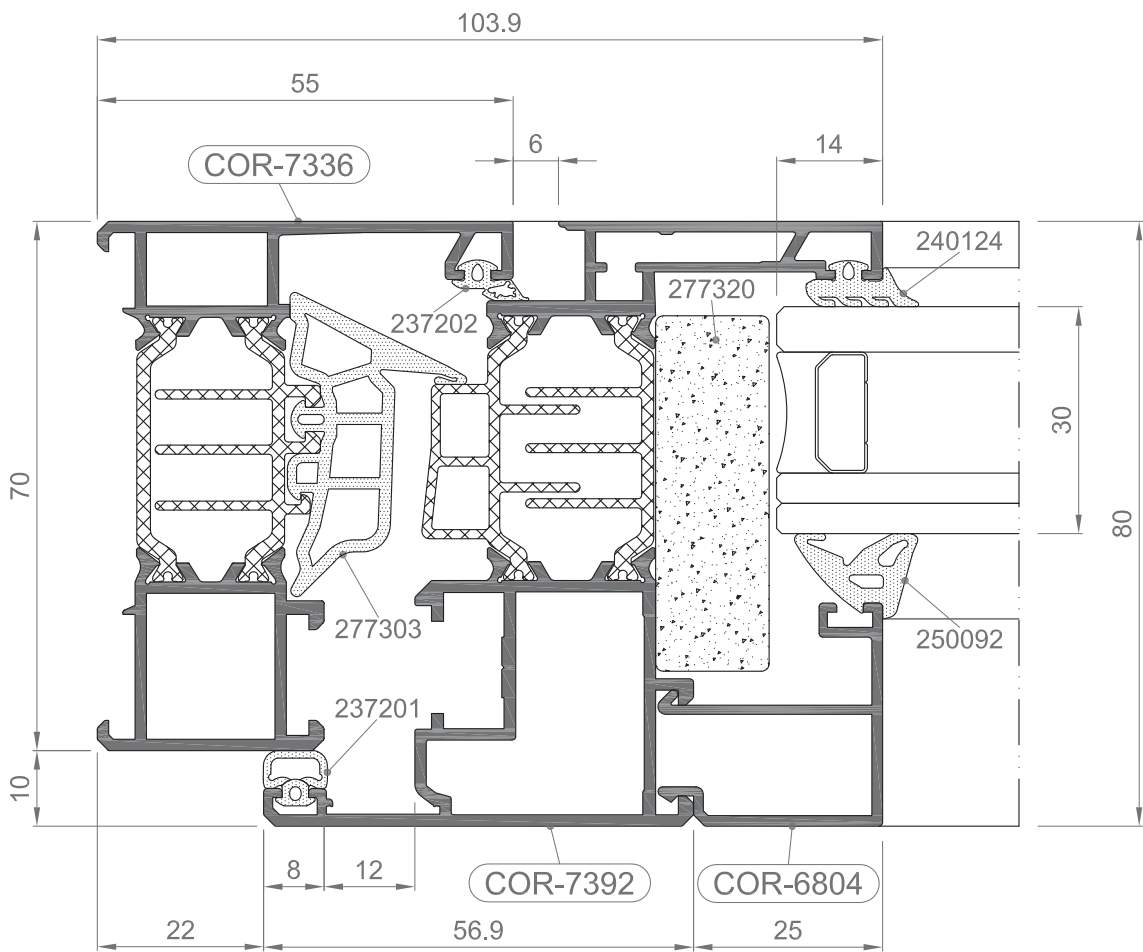
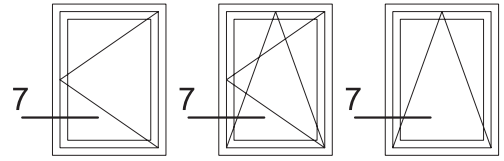

E 1:1

ABATIBLE MOTORIZADA

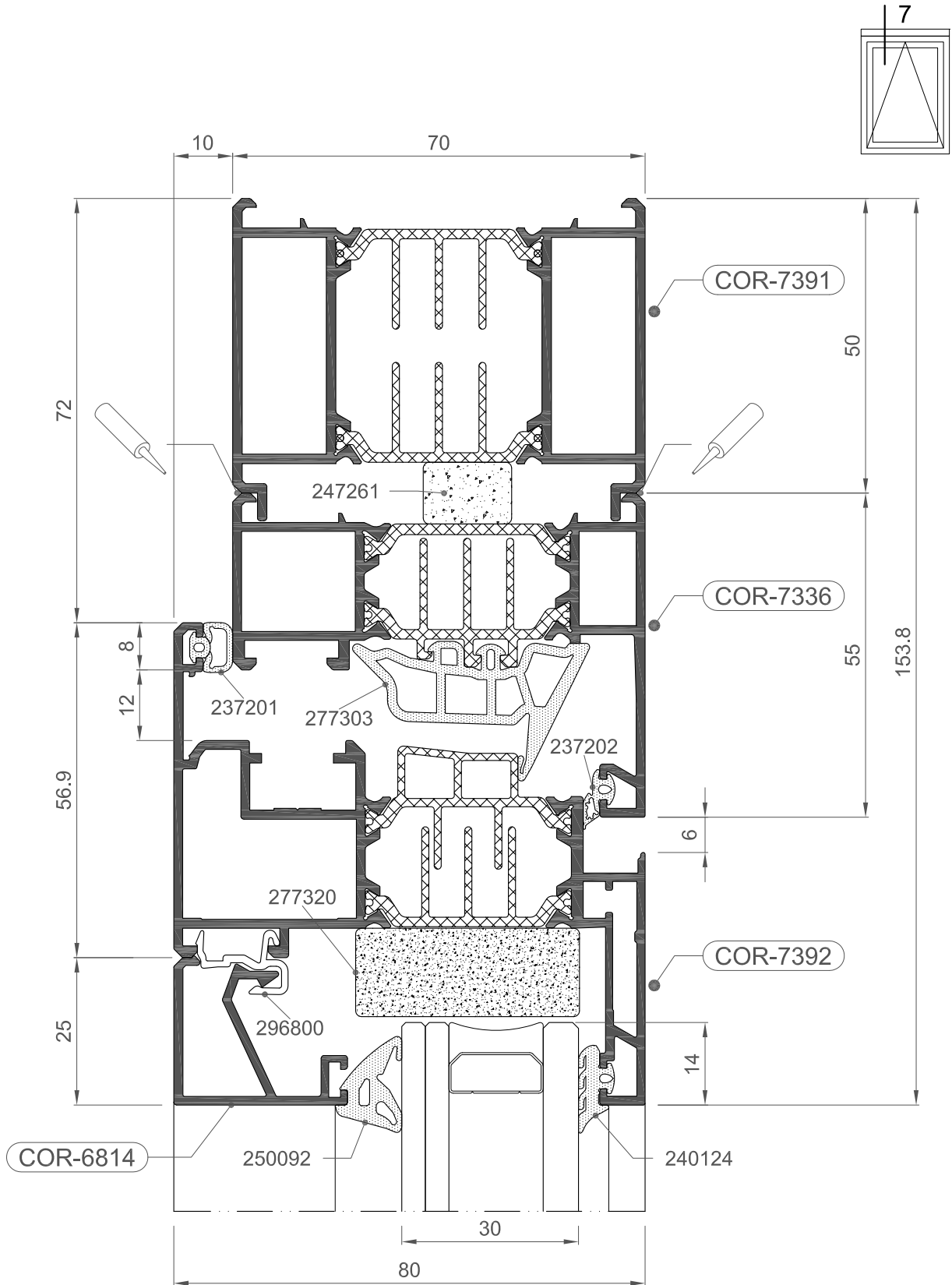

COR 70 CC16

Nudos constructivos

E 1:1

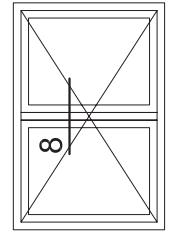
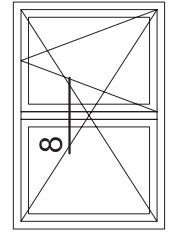
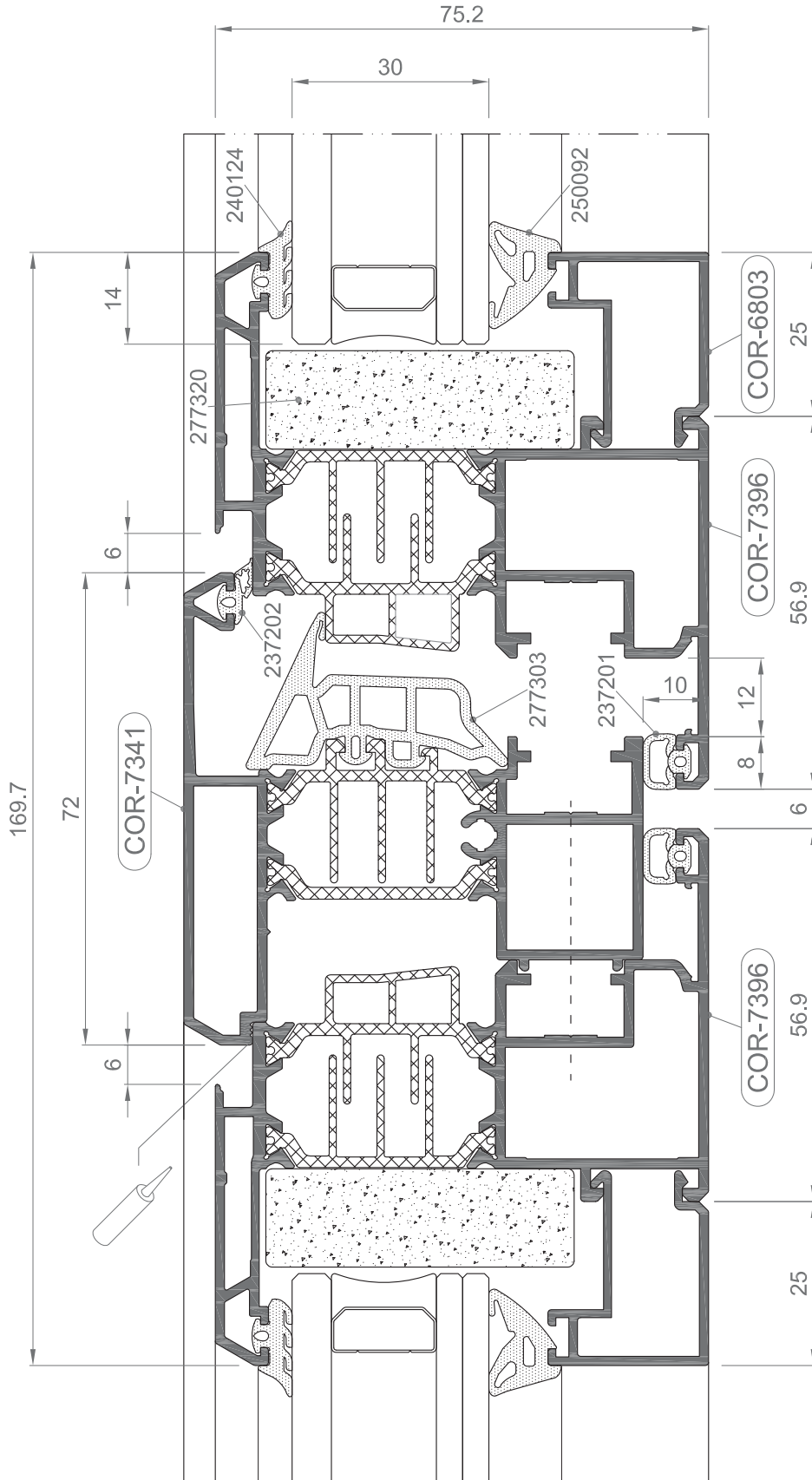

COR 70 CC16

Nudos constructivos

E 1:1

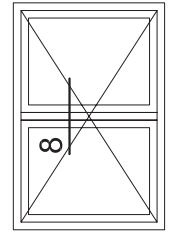
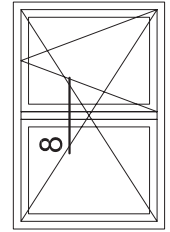
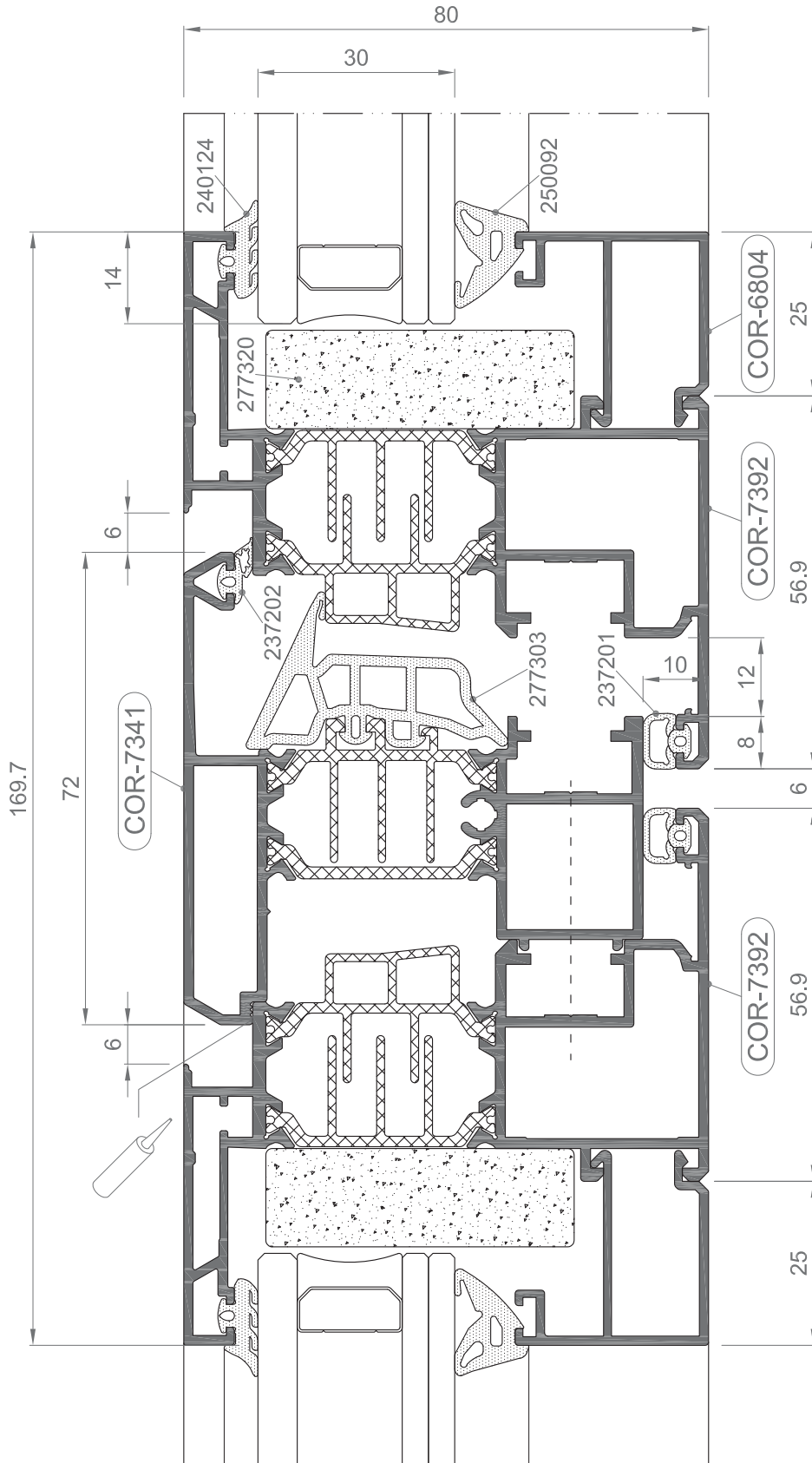

COR 70 CC16

Nudos constructivos

E 1:1

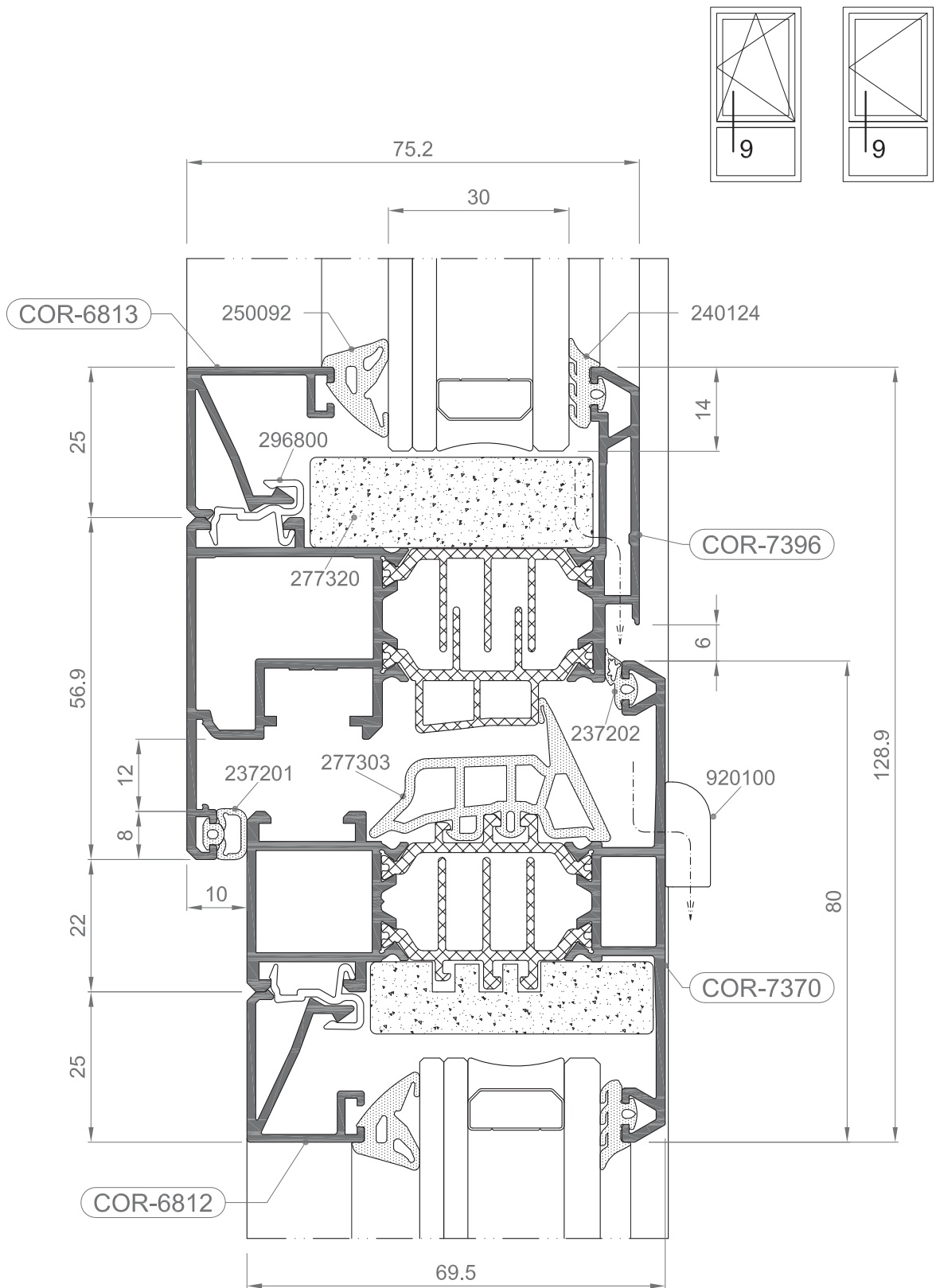

E 1:1

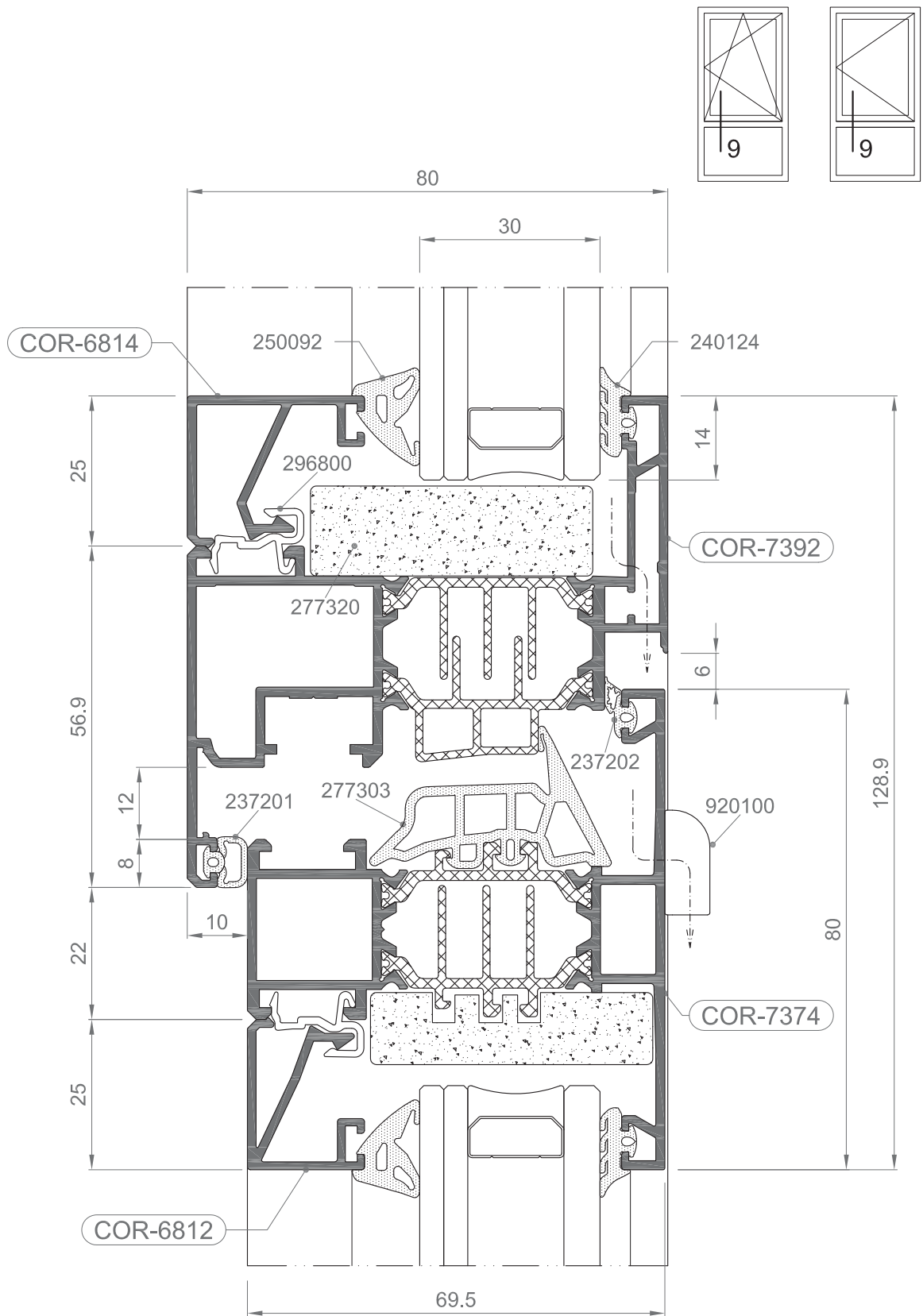

COR 70 CC16

Nudos constructivos

E 1:1

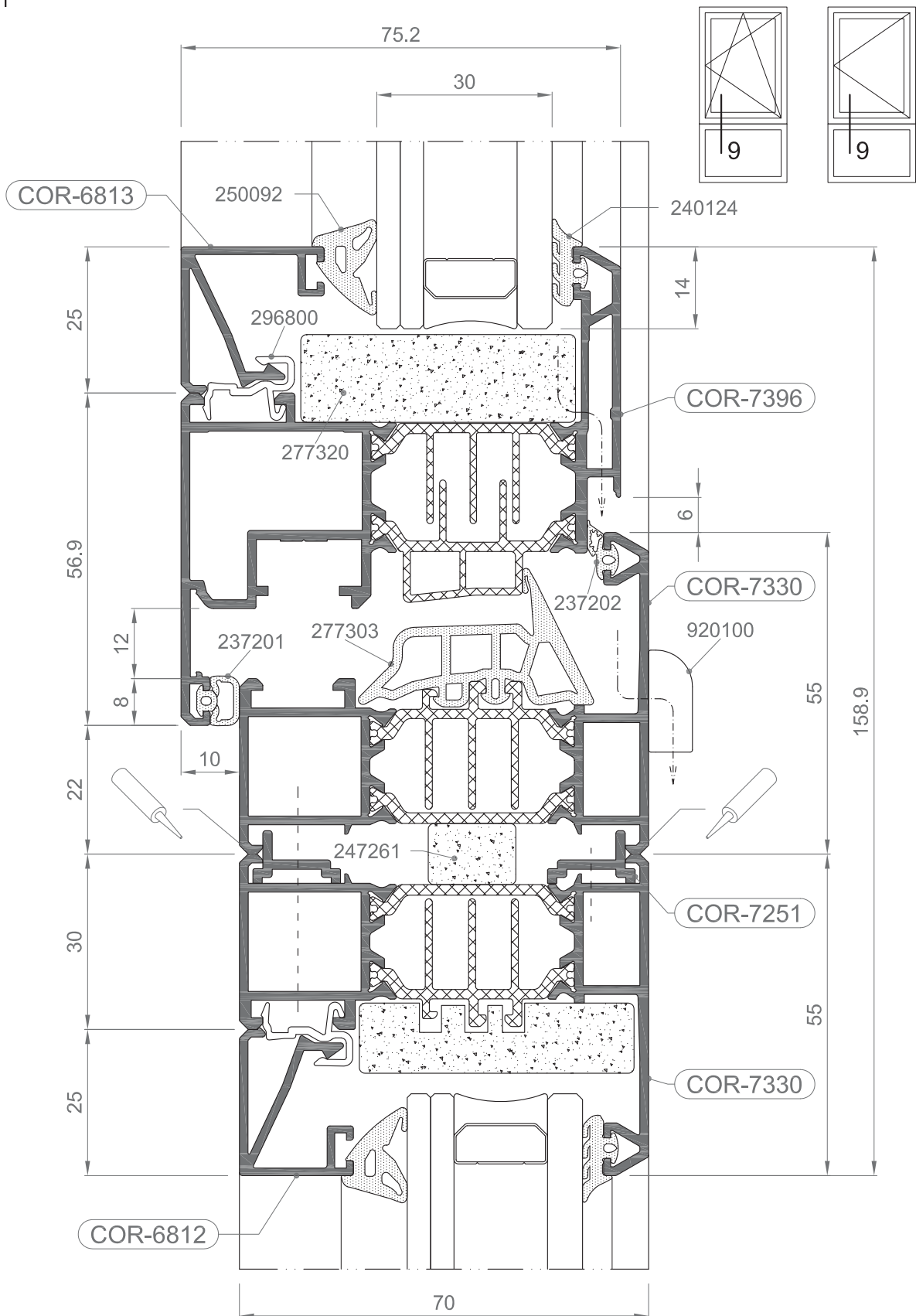

E 1:1

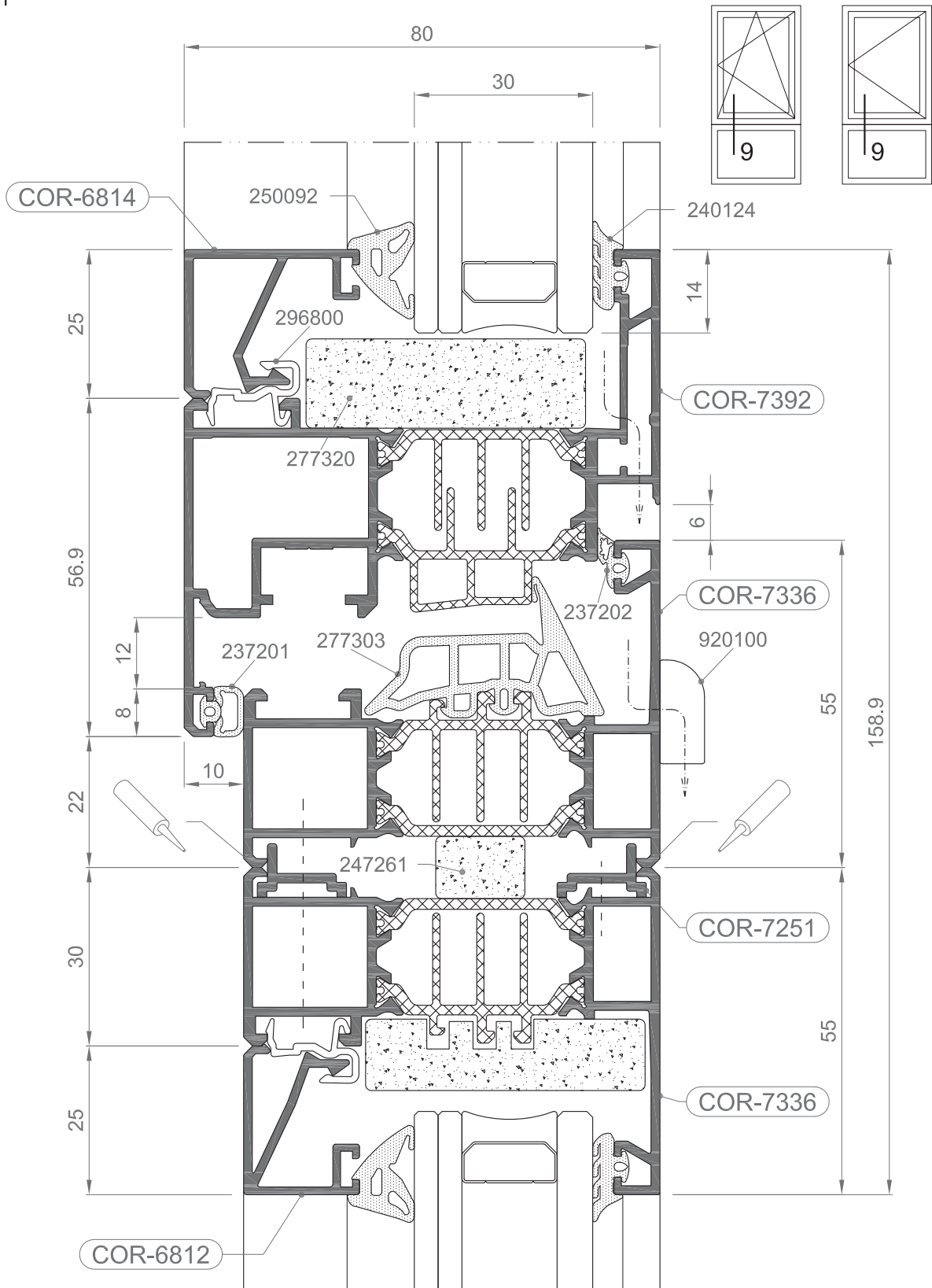

COR 70 CC16

Nudos constructivos

E 1:1

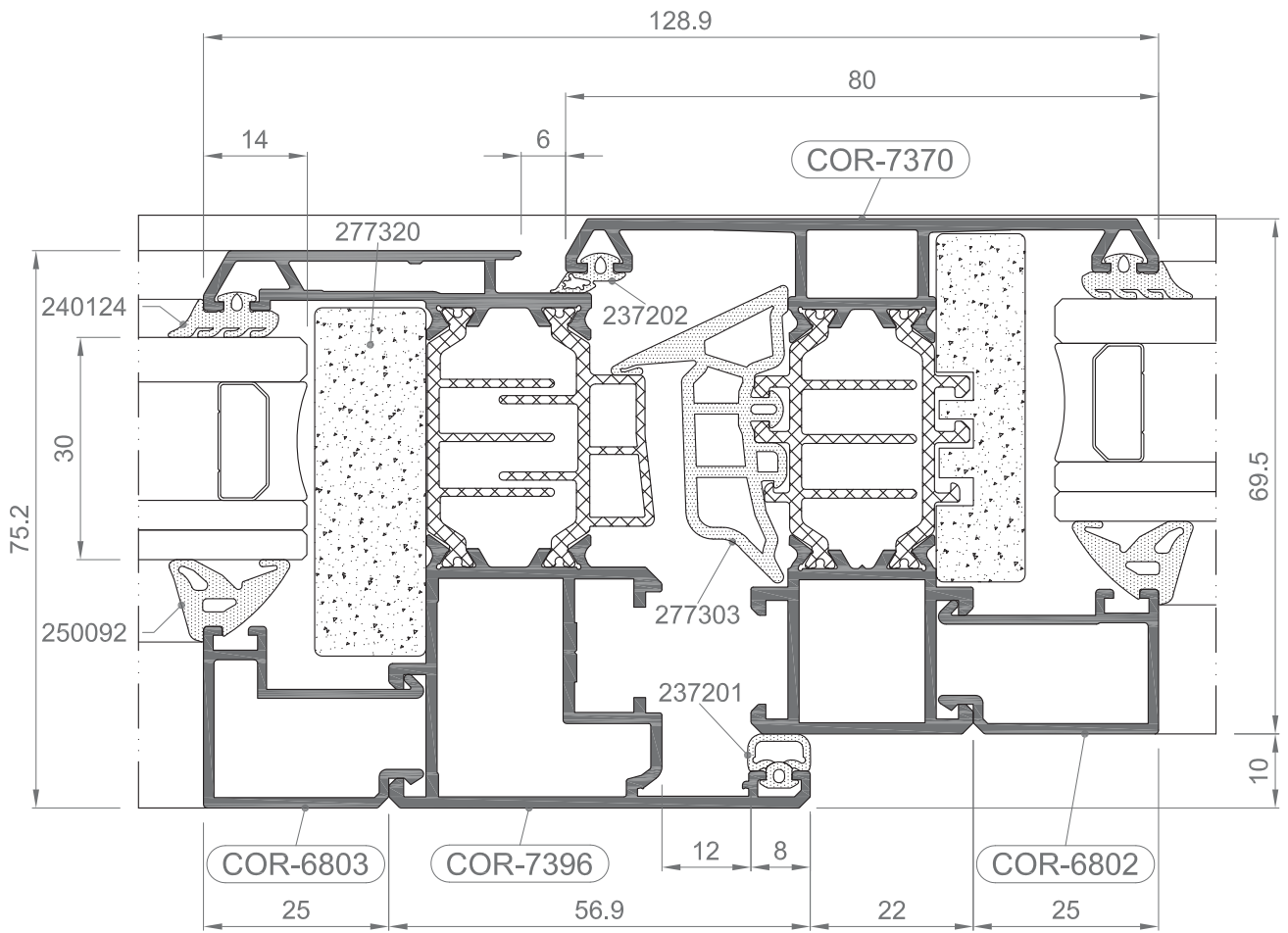
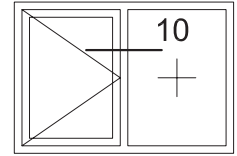
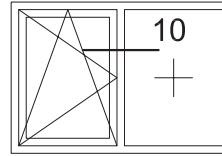

E 1:1

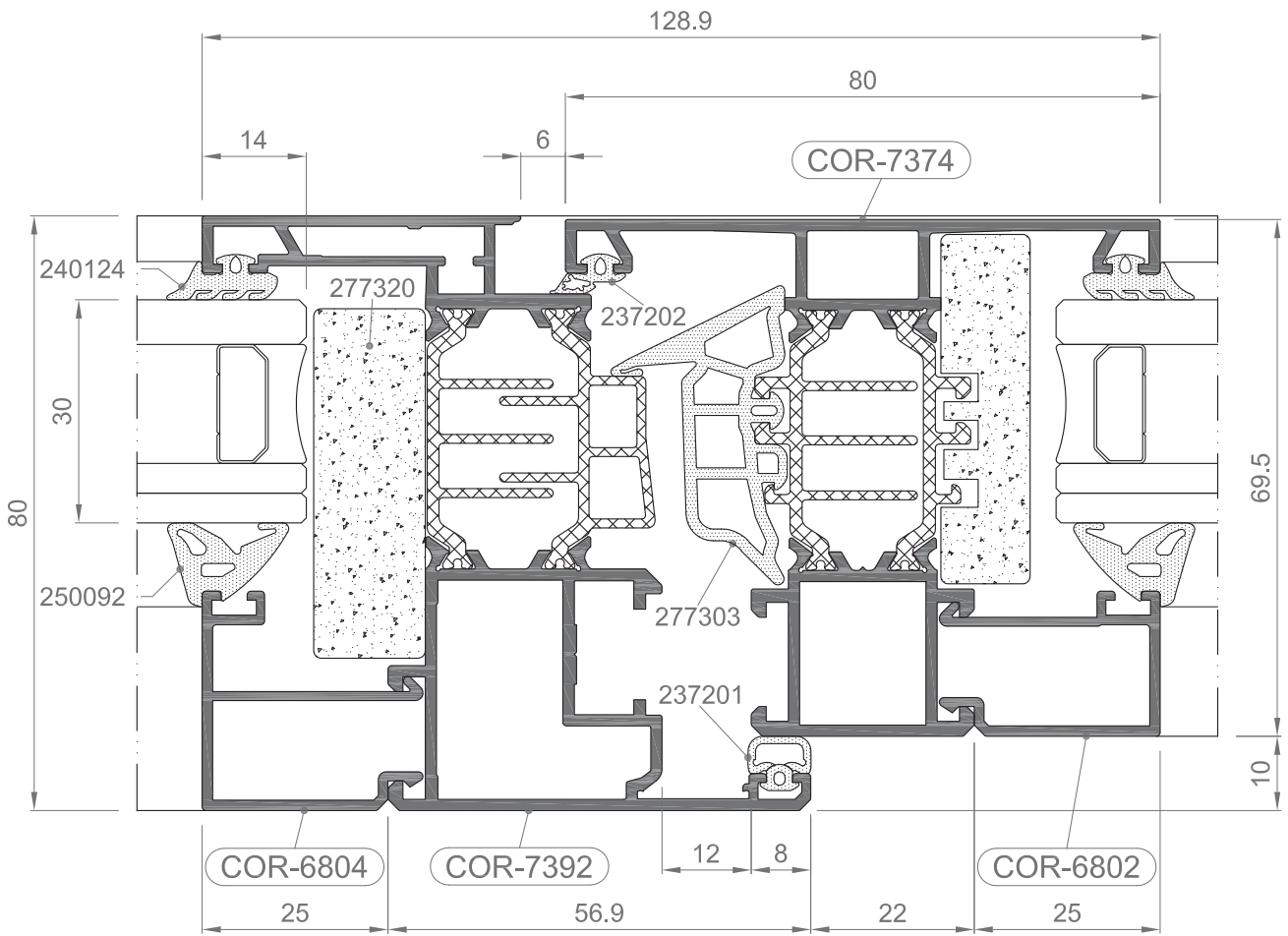
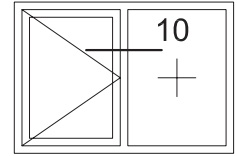
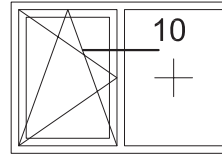

E 1:1

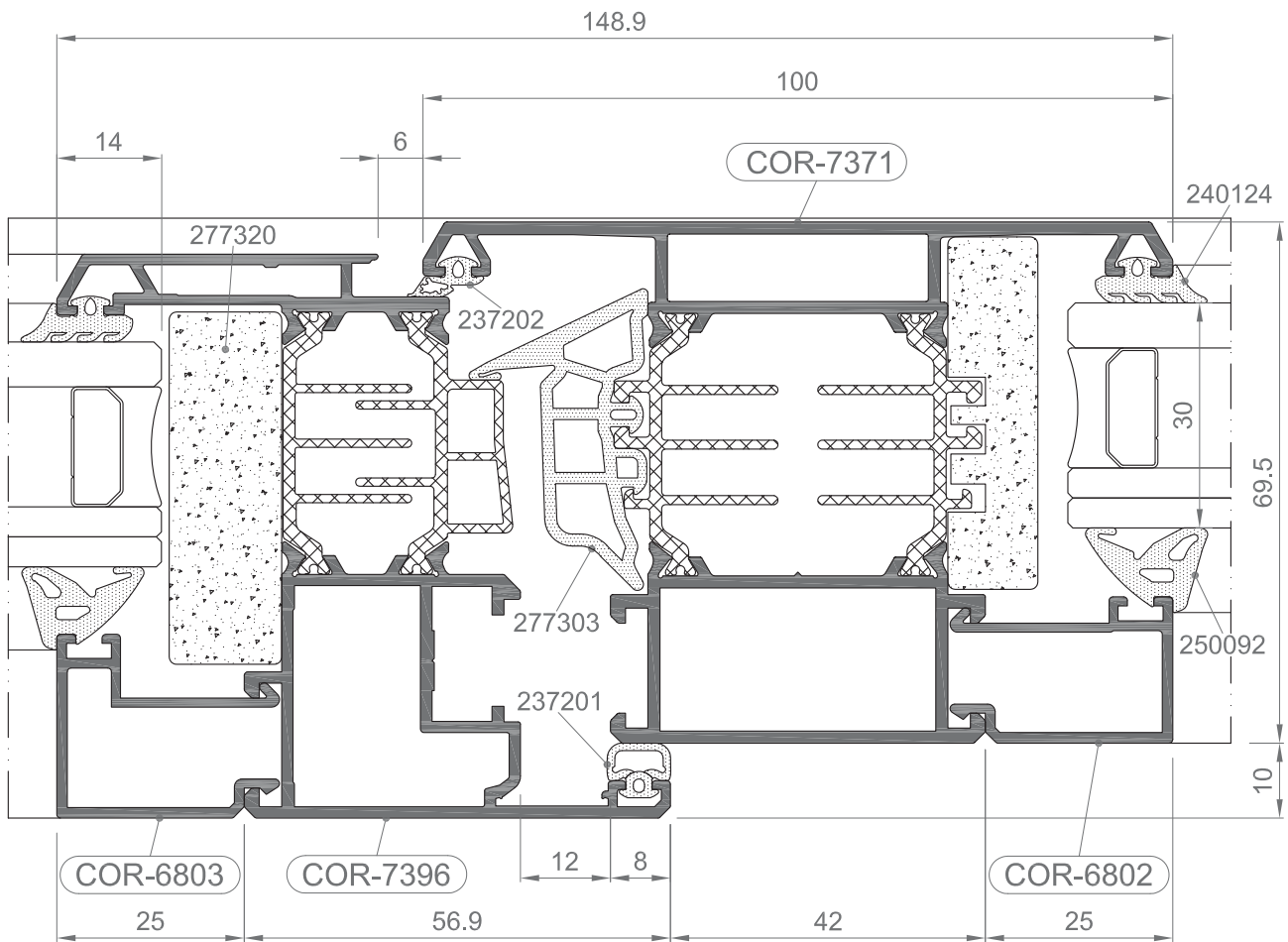
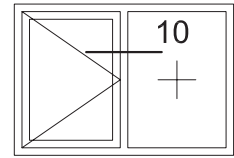
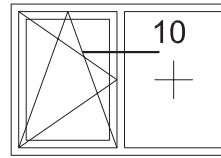

E 1:1

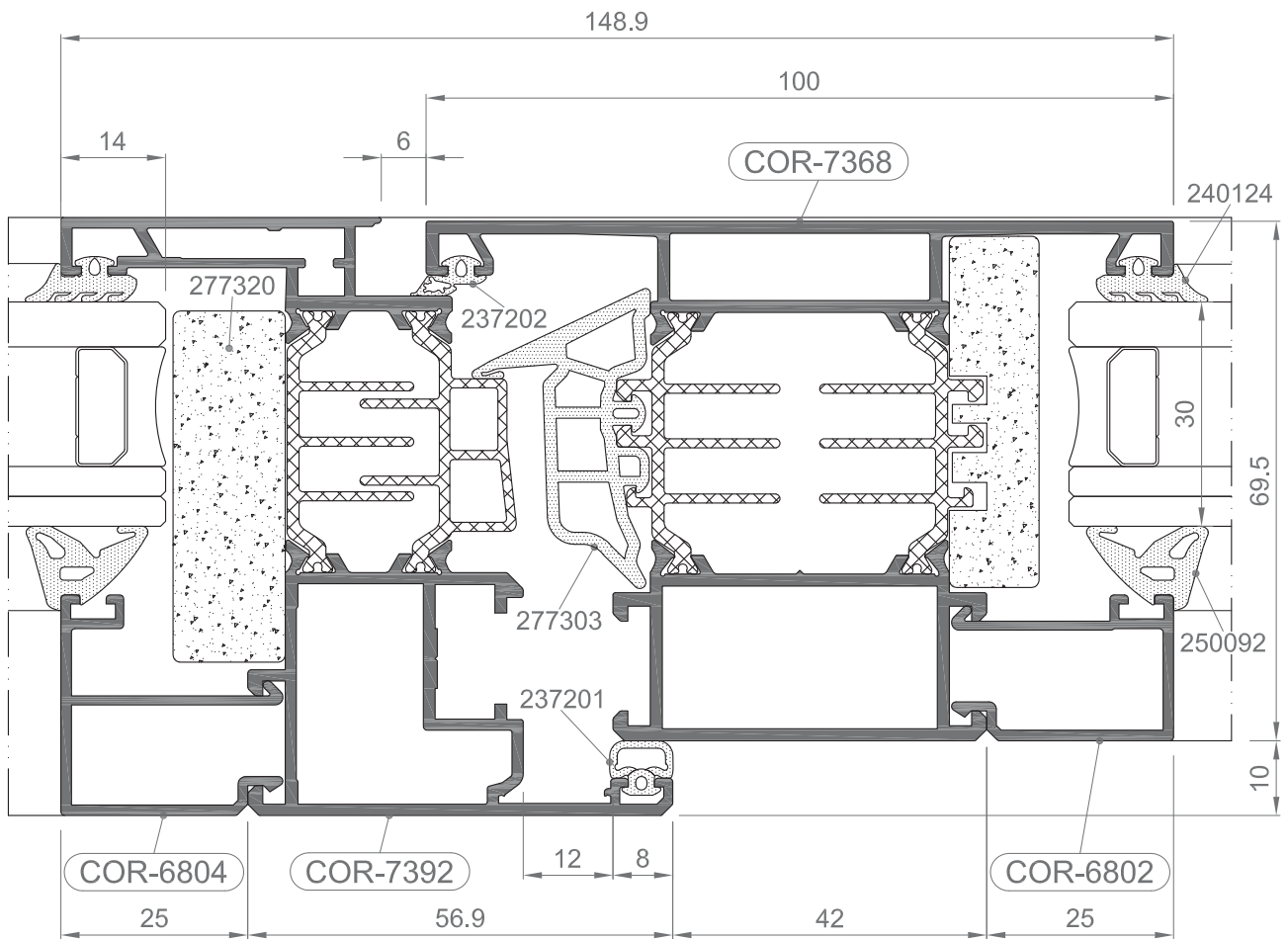
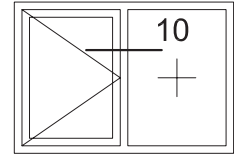
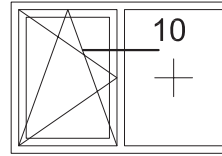

E 1:1

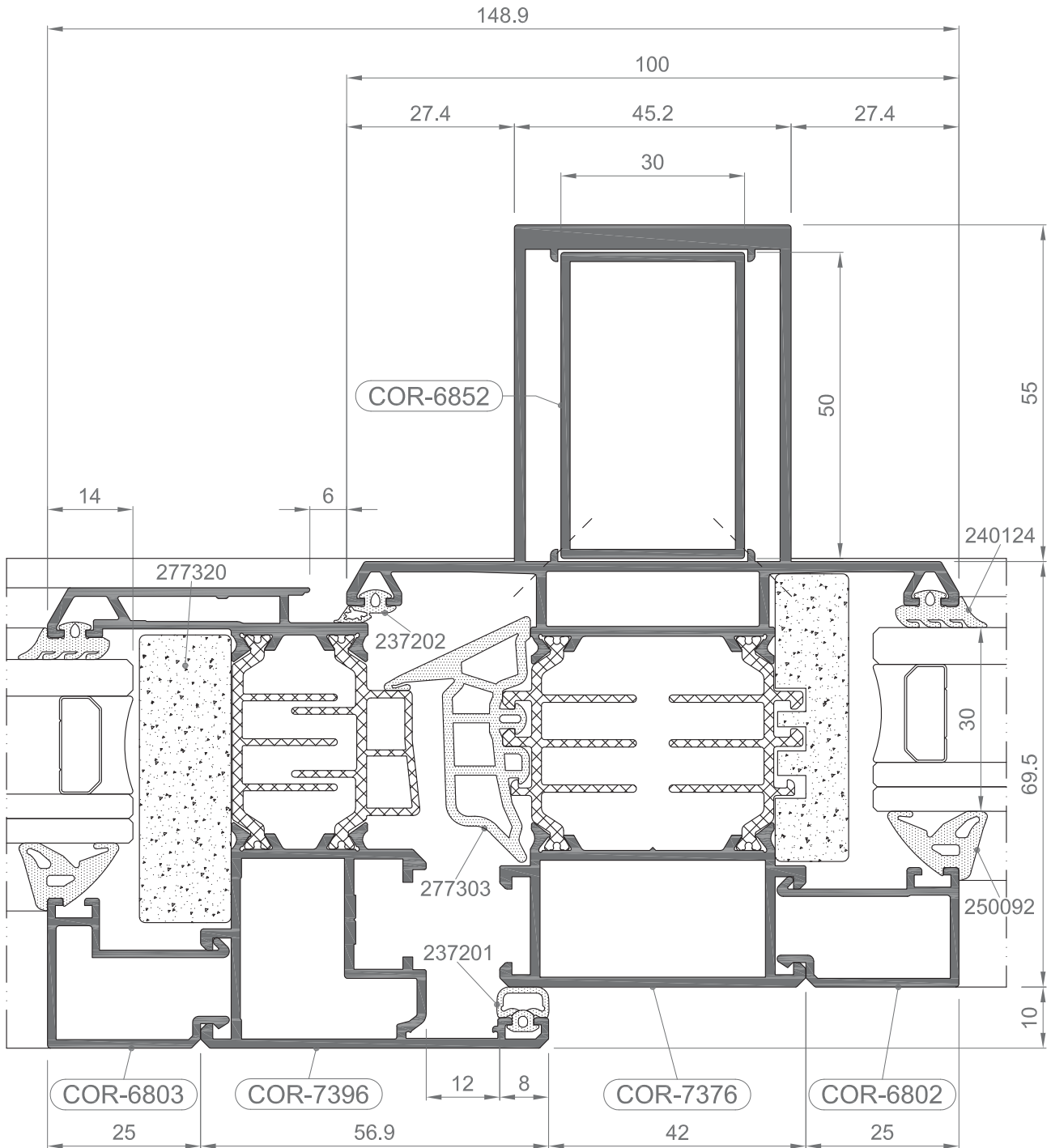
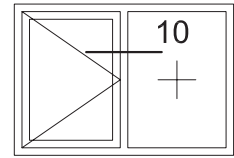
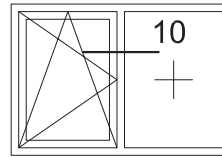

COR 70 CC16

Nudos constructivos

E 1:1

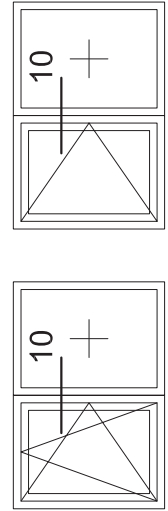
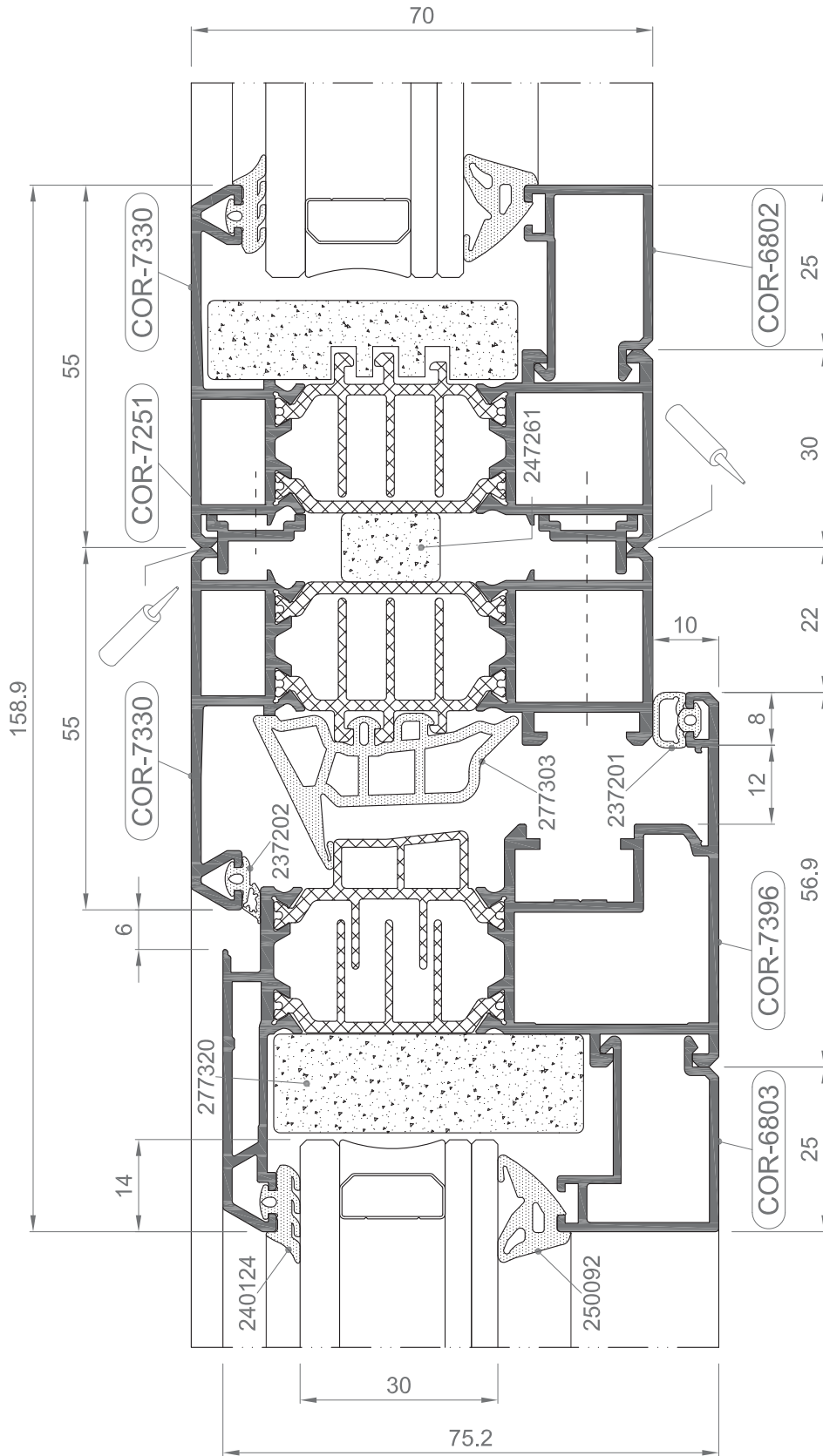

COR 70 CC16

Nudos constructivos

E 1:1

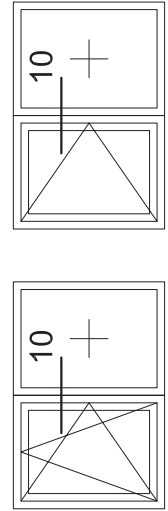
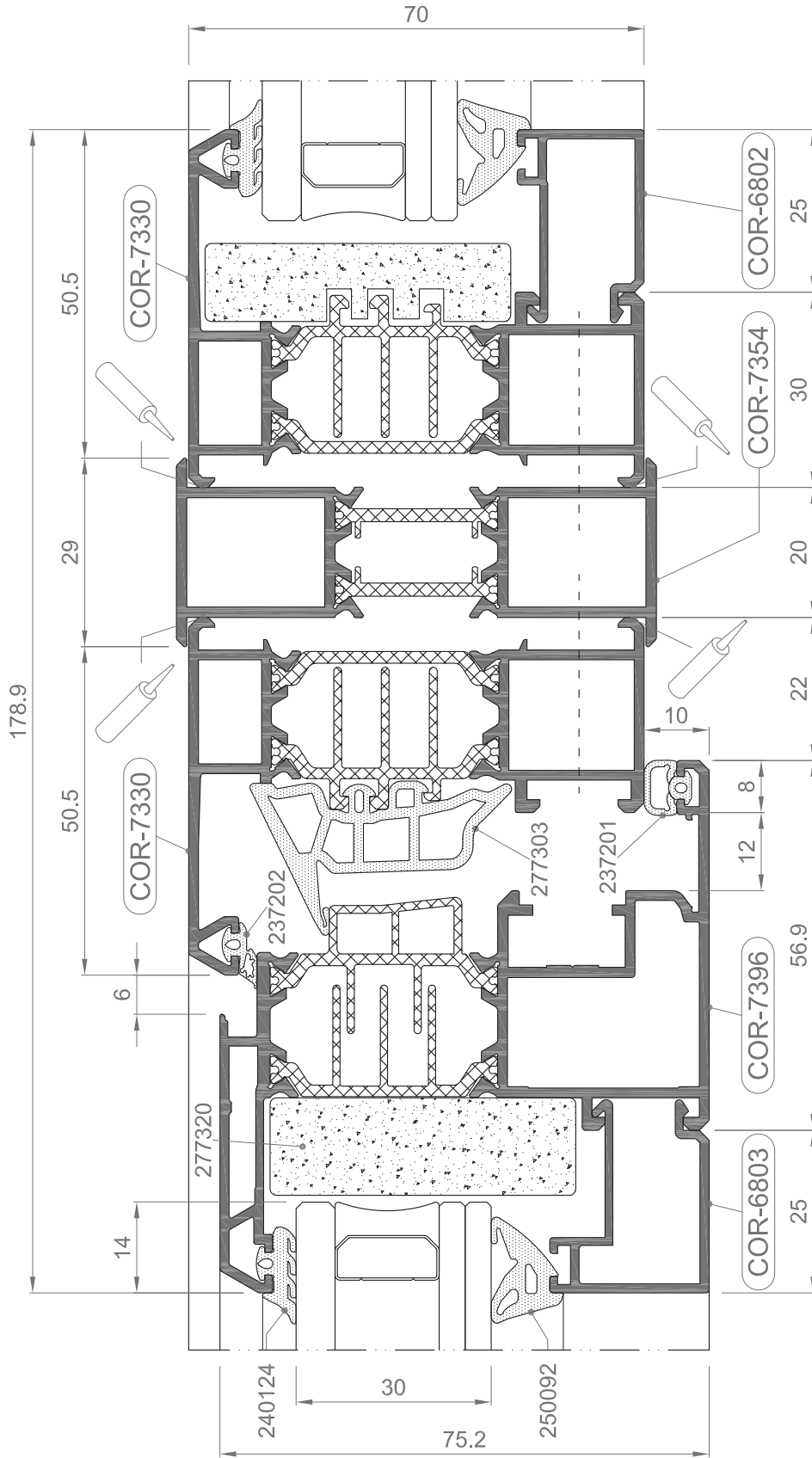

COR 70 CC16

Nudos constructivos

E 1:1

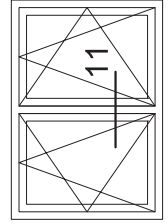
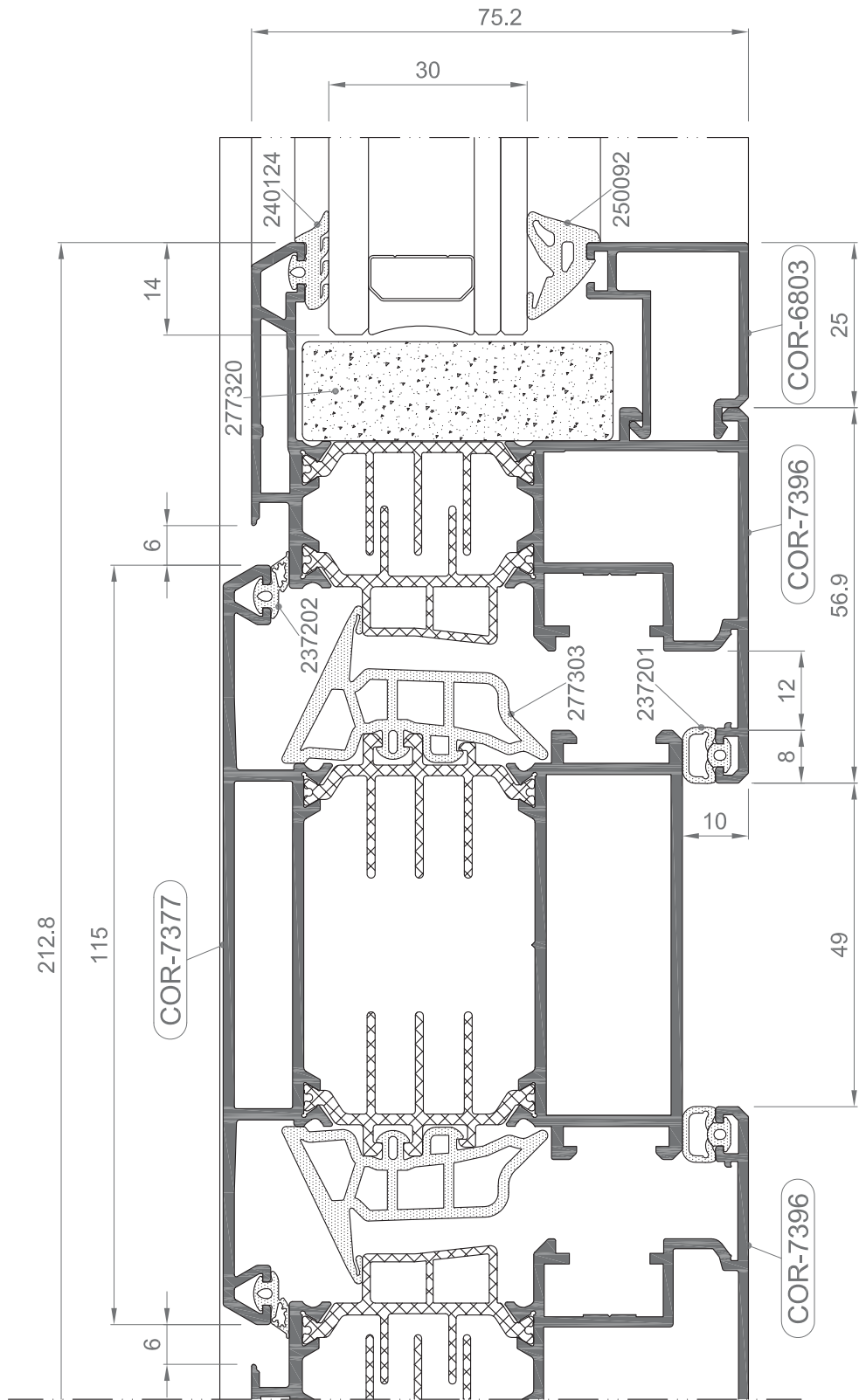

COR 70 CC16

Nudos constructivos

E 1:1

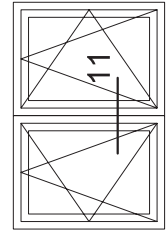
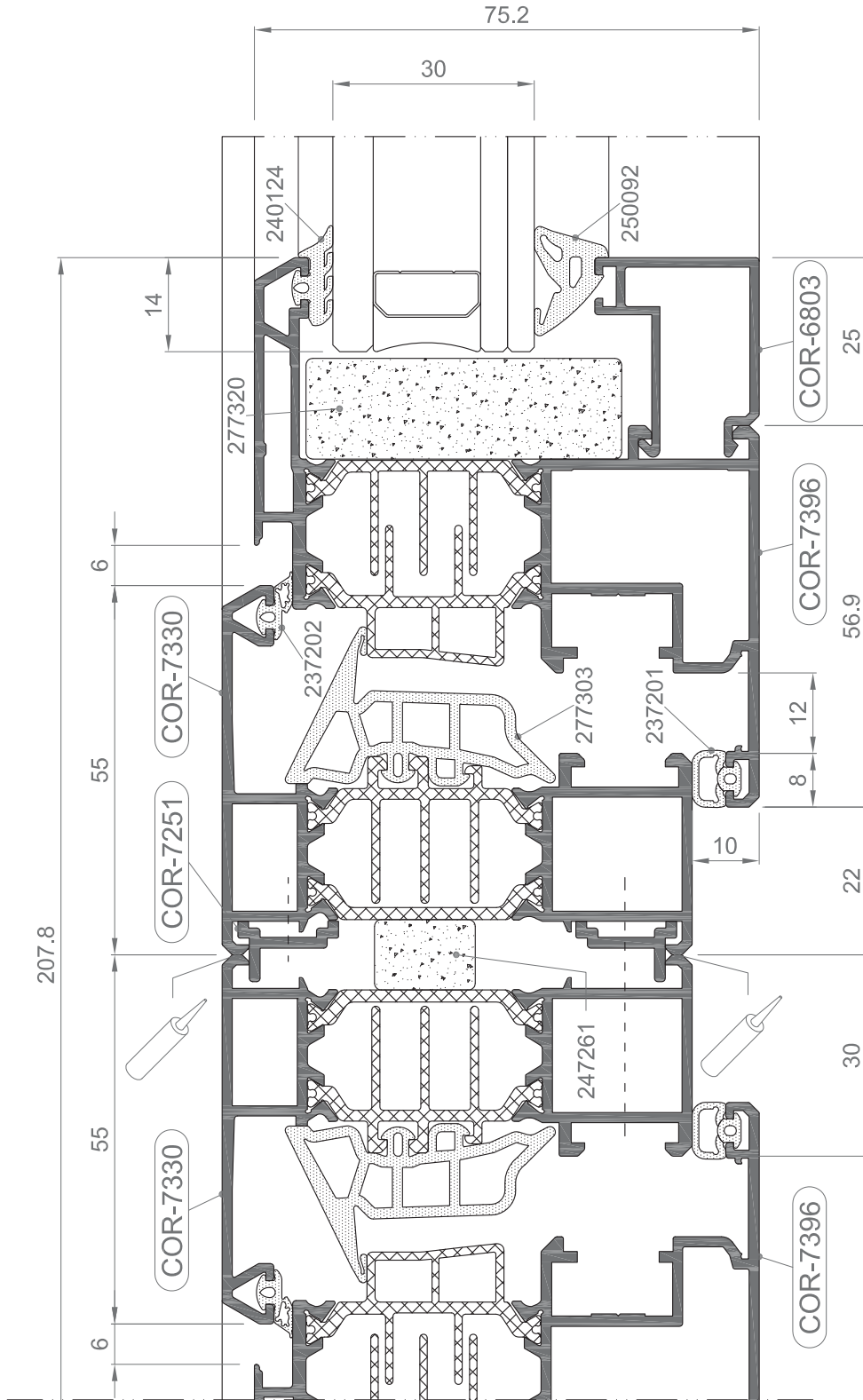

E 1:1

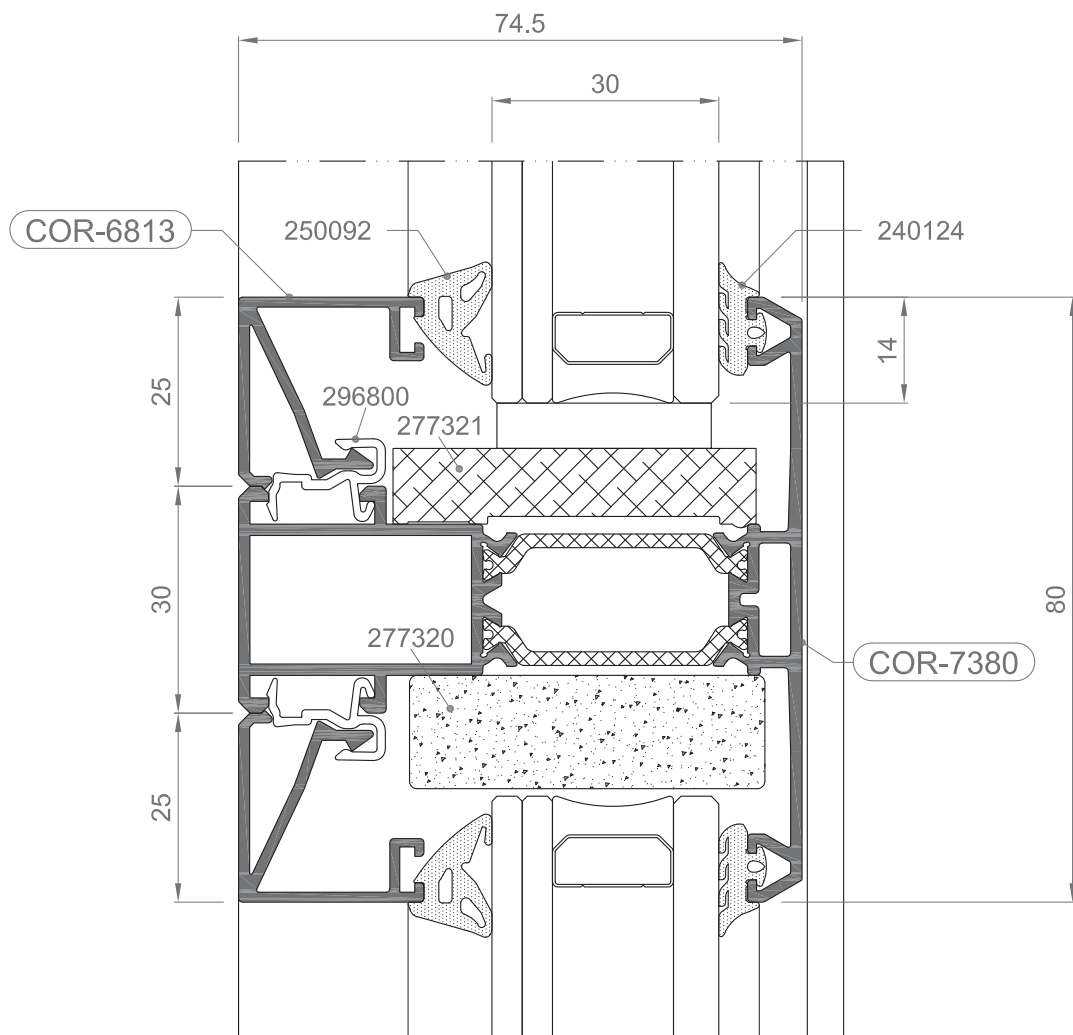
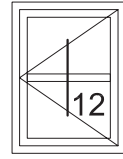
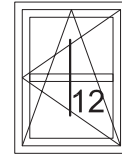

E 1:1

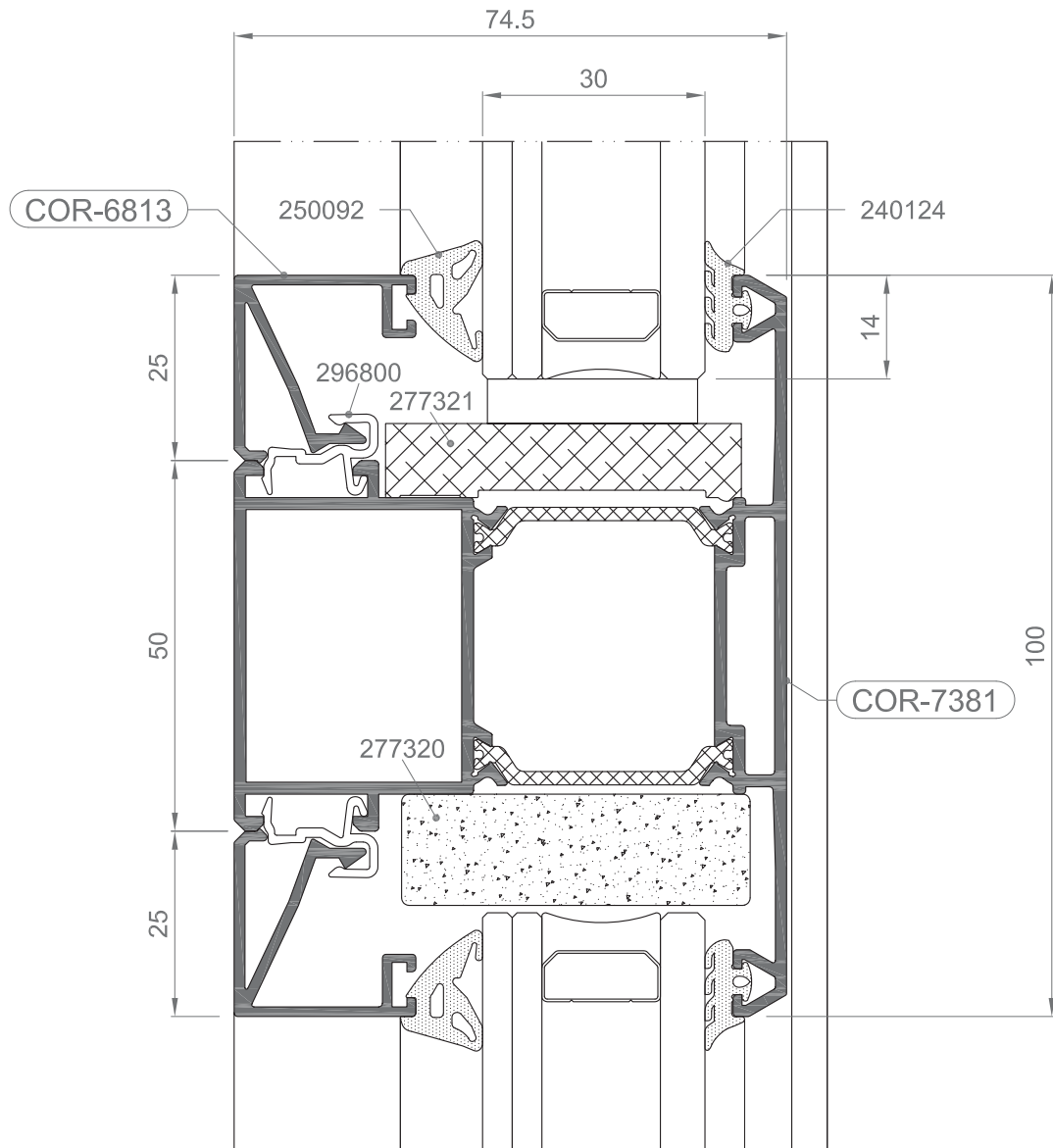
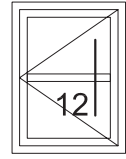
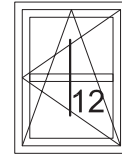

E 1:1

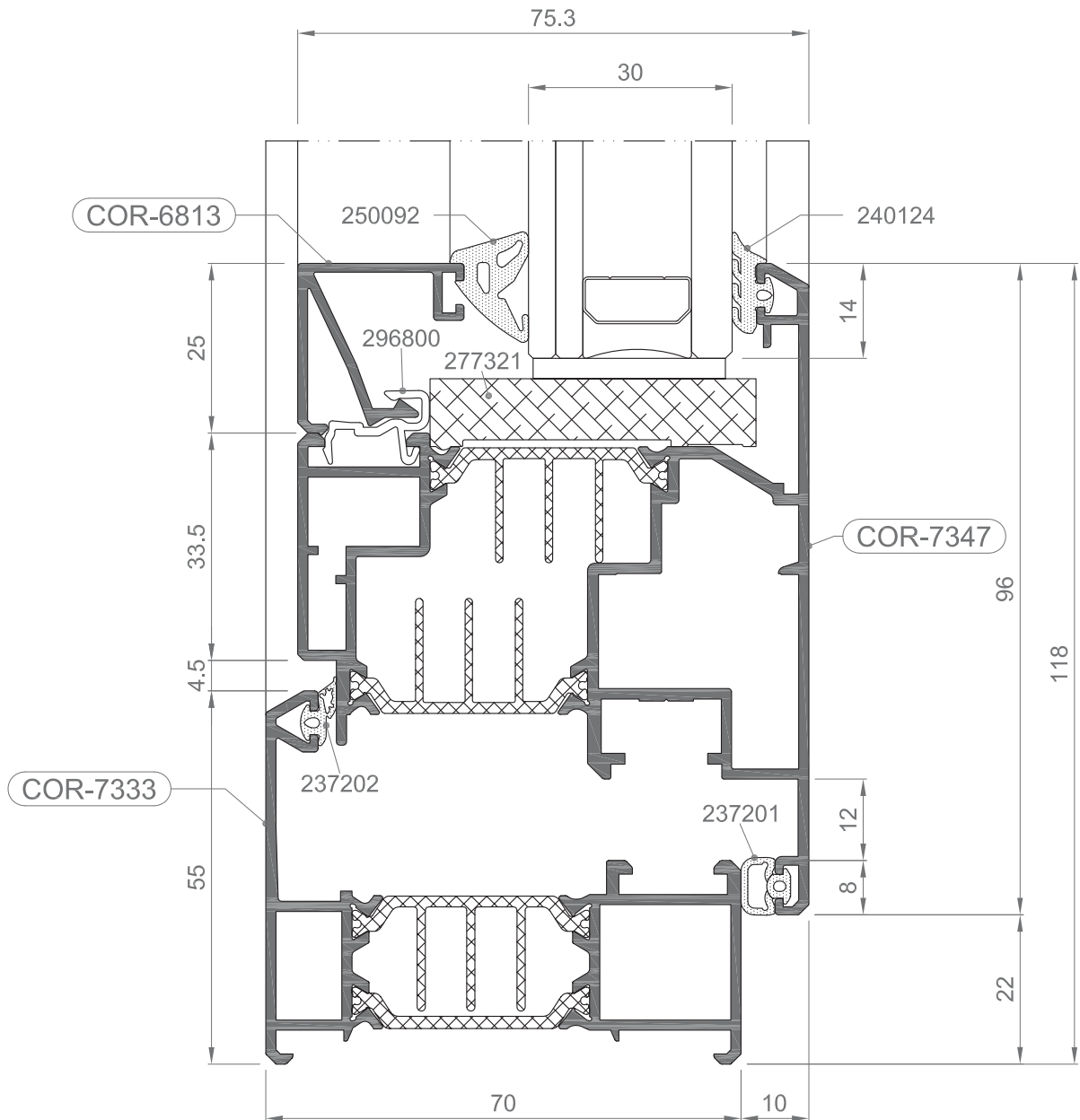
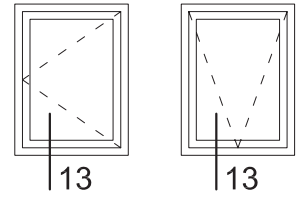

E 1:1

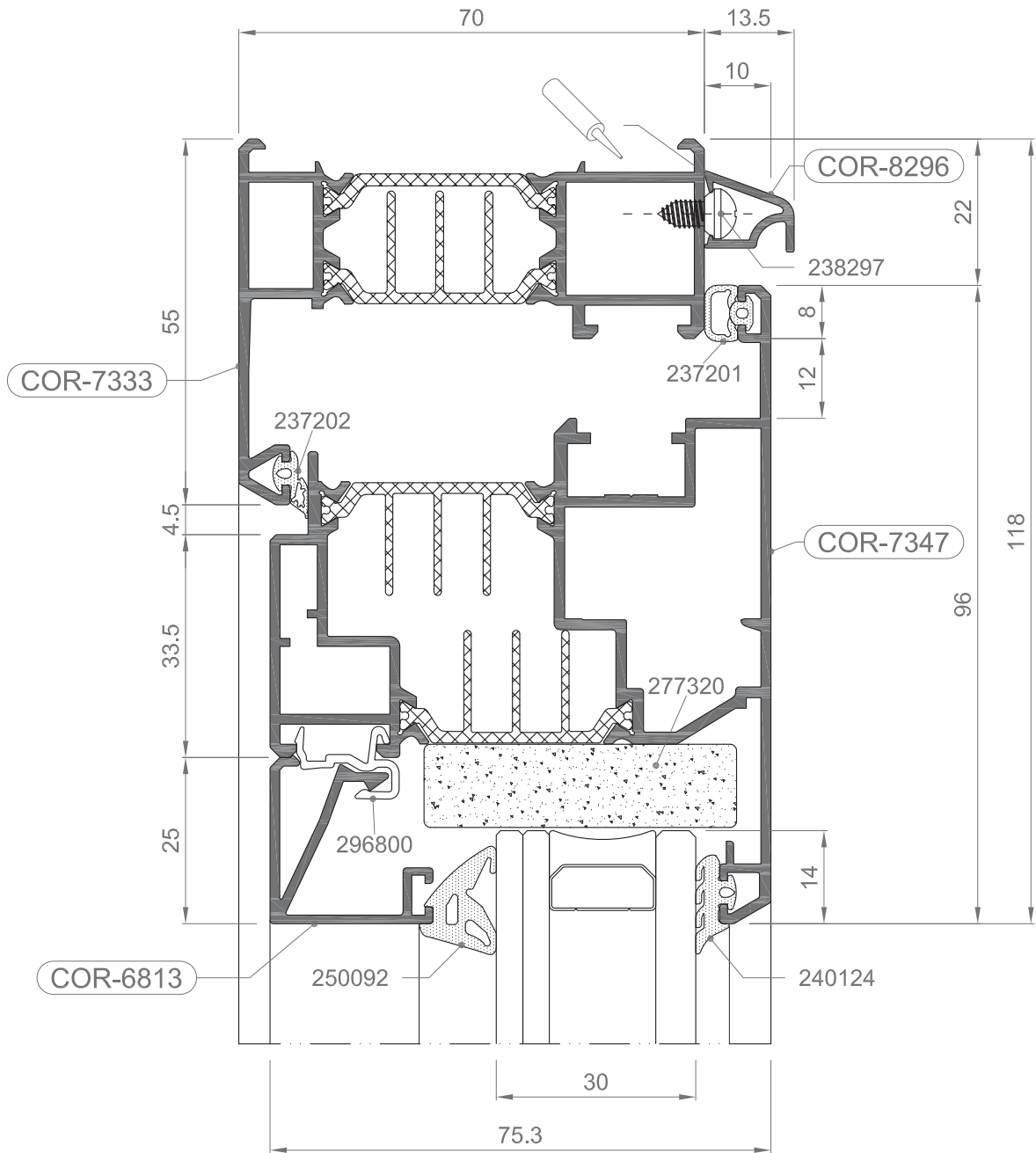
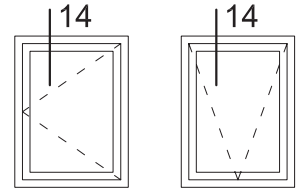

E 1:1

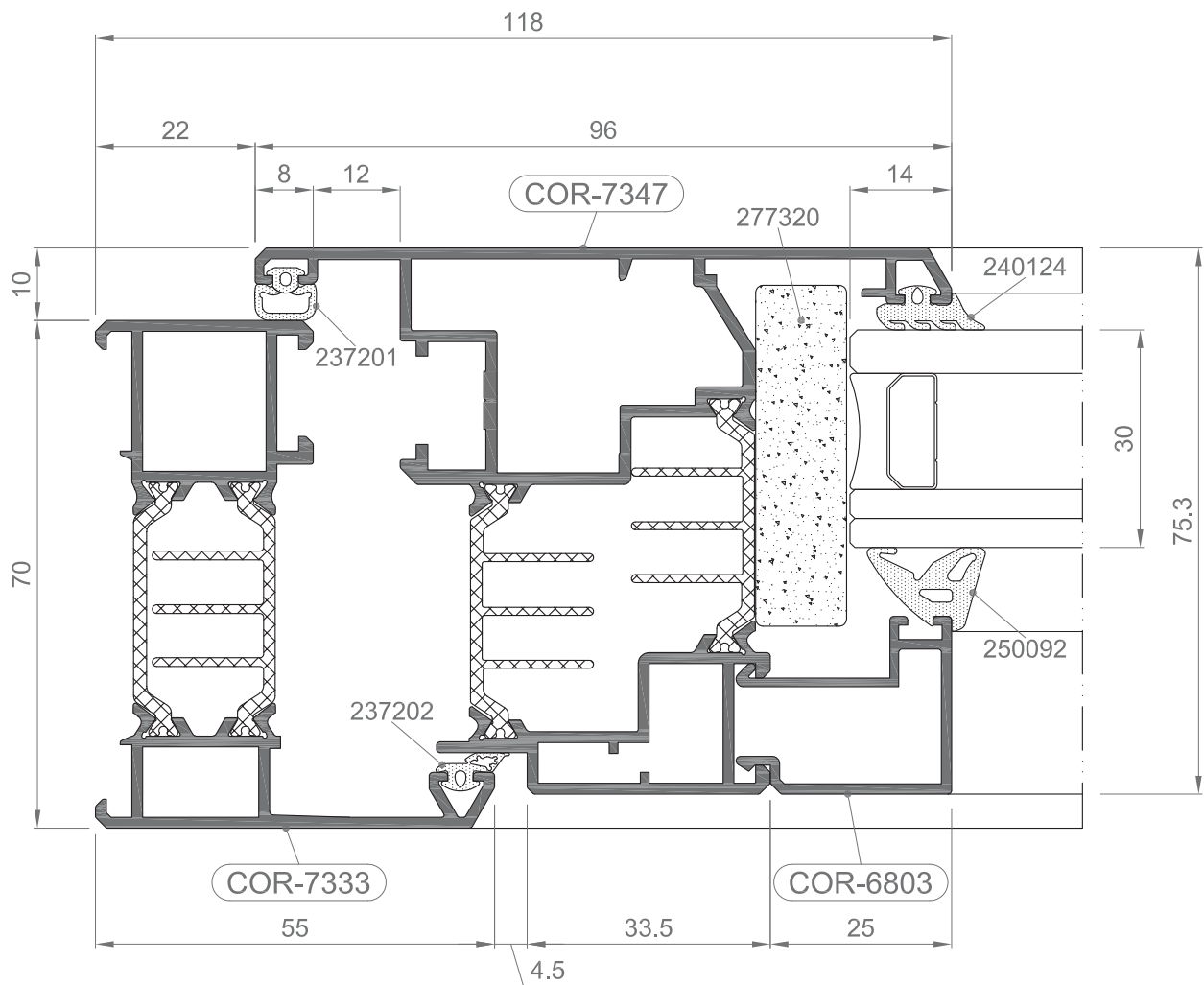
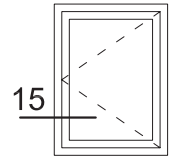

E 1:1

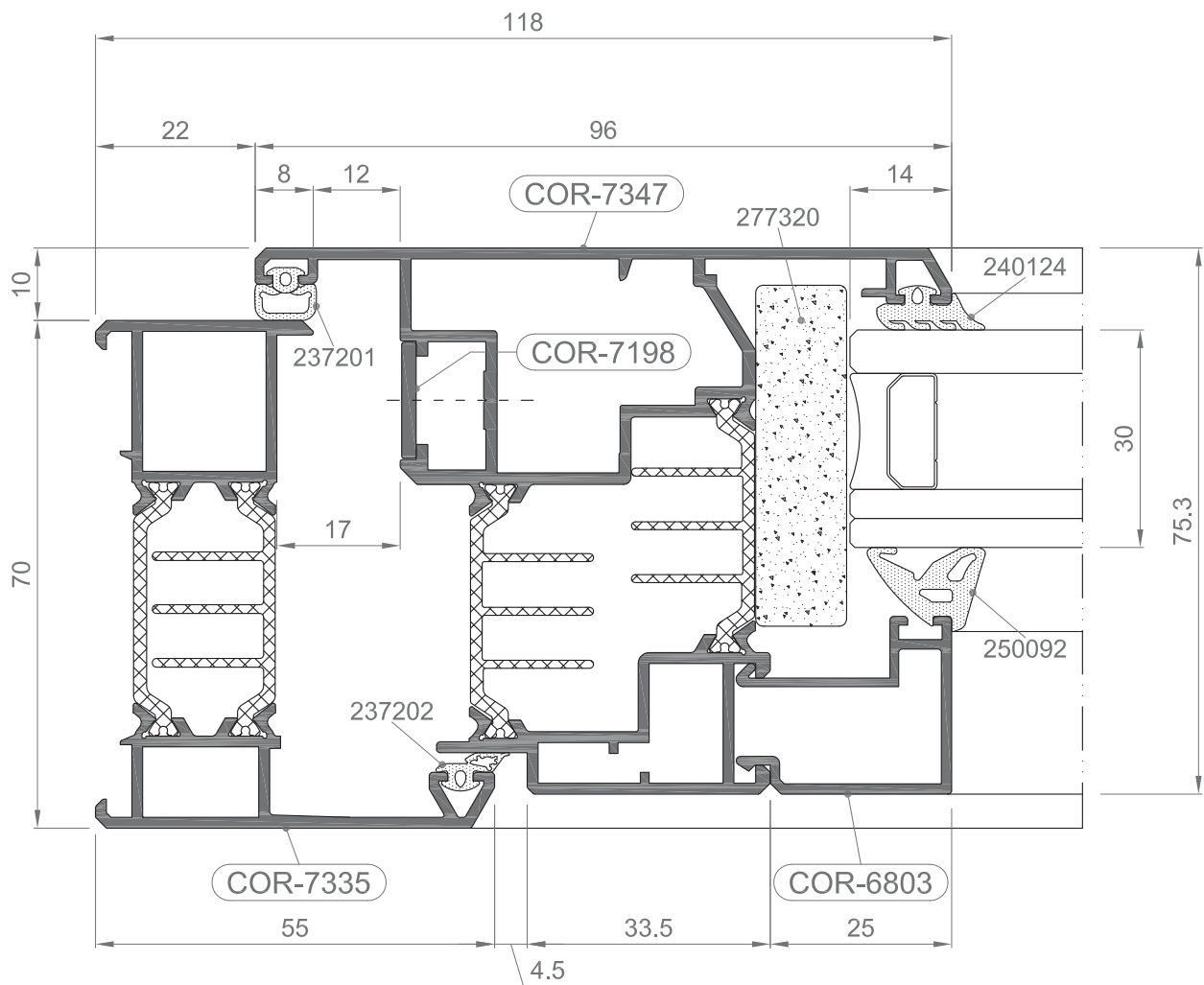
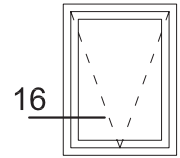

COR 70 CC16

Nudos constructivos

E 1:1

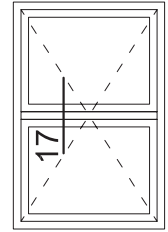
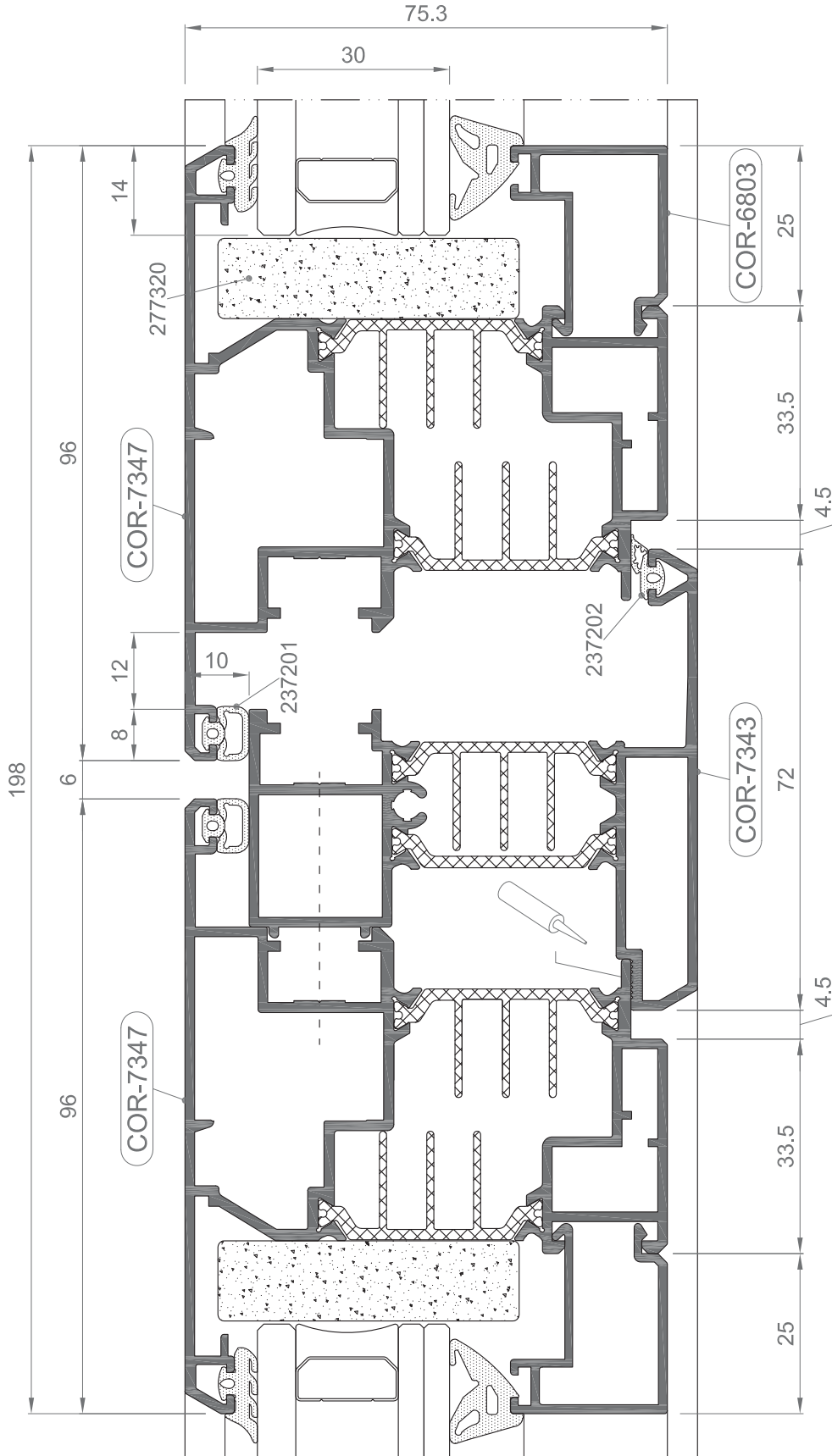

COR 70 CC16

Nudos constructivos

E 1:1

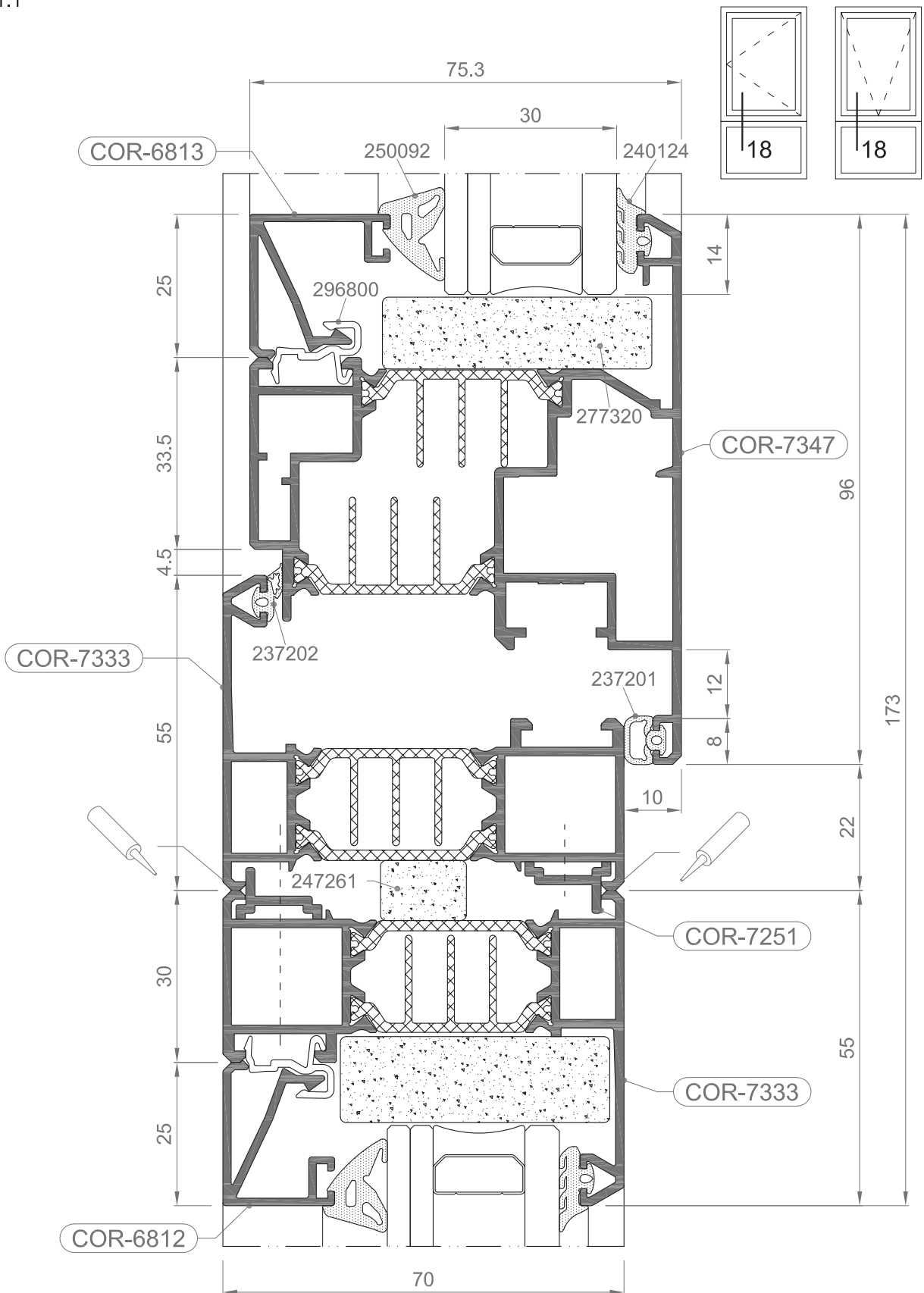

COR 70 CC16

Nudos constructivos

E 1:1

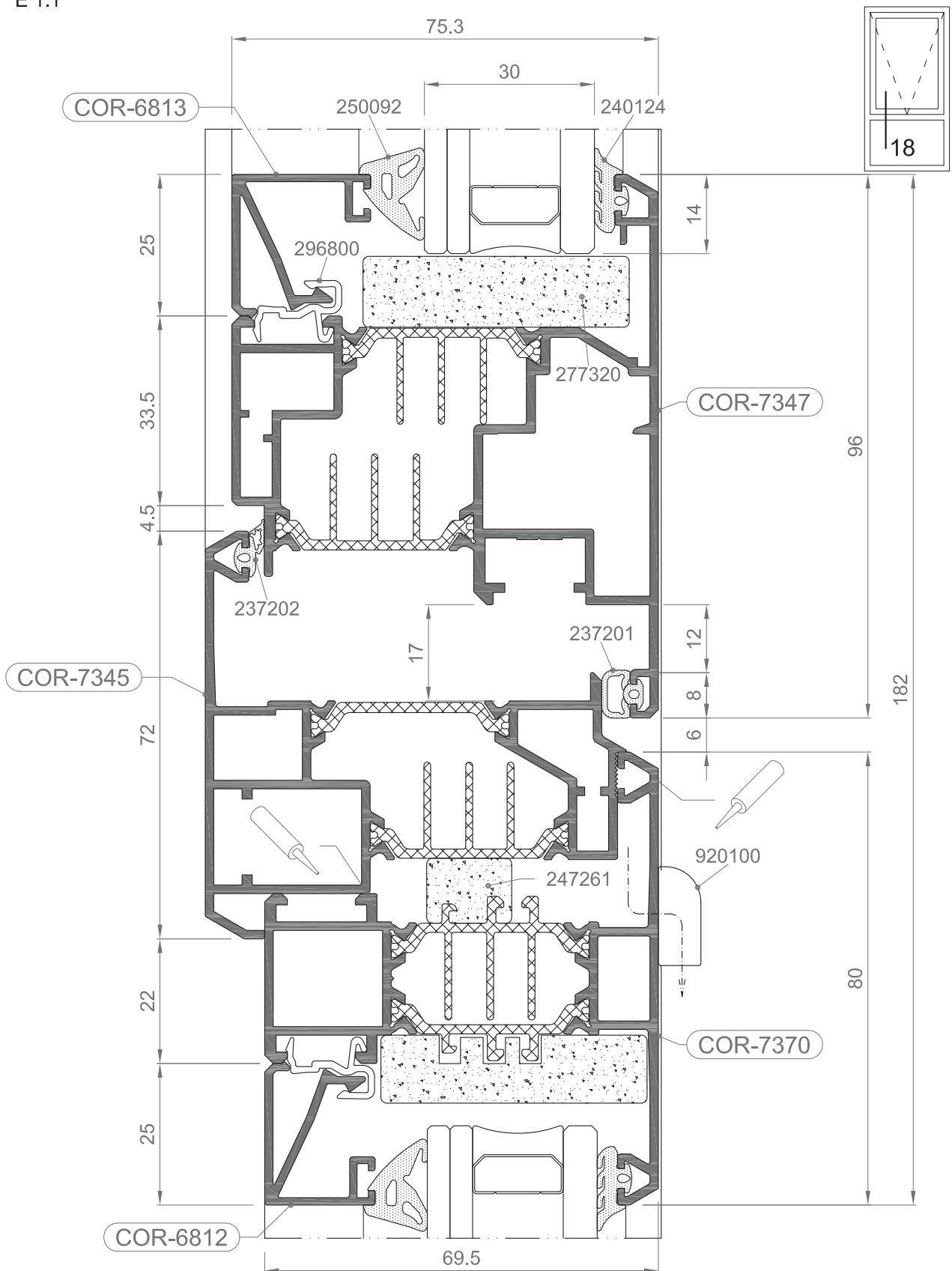

COR 70 CC16

Nudos constructivos

E 1:1

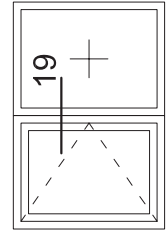
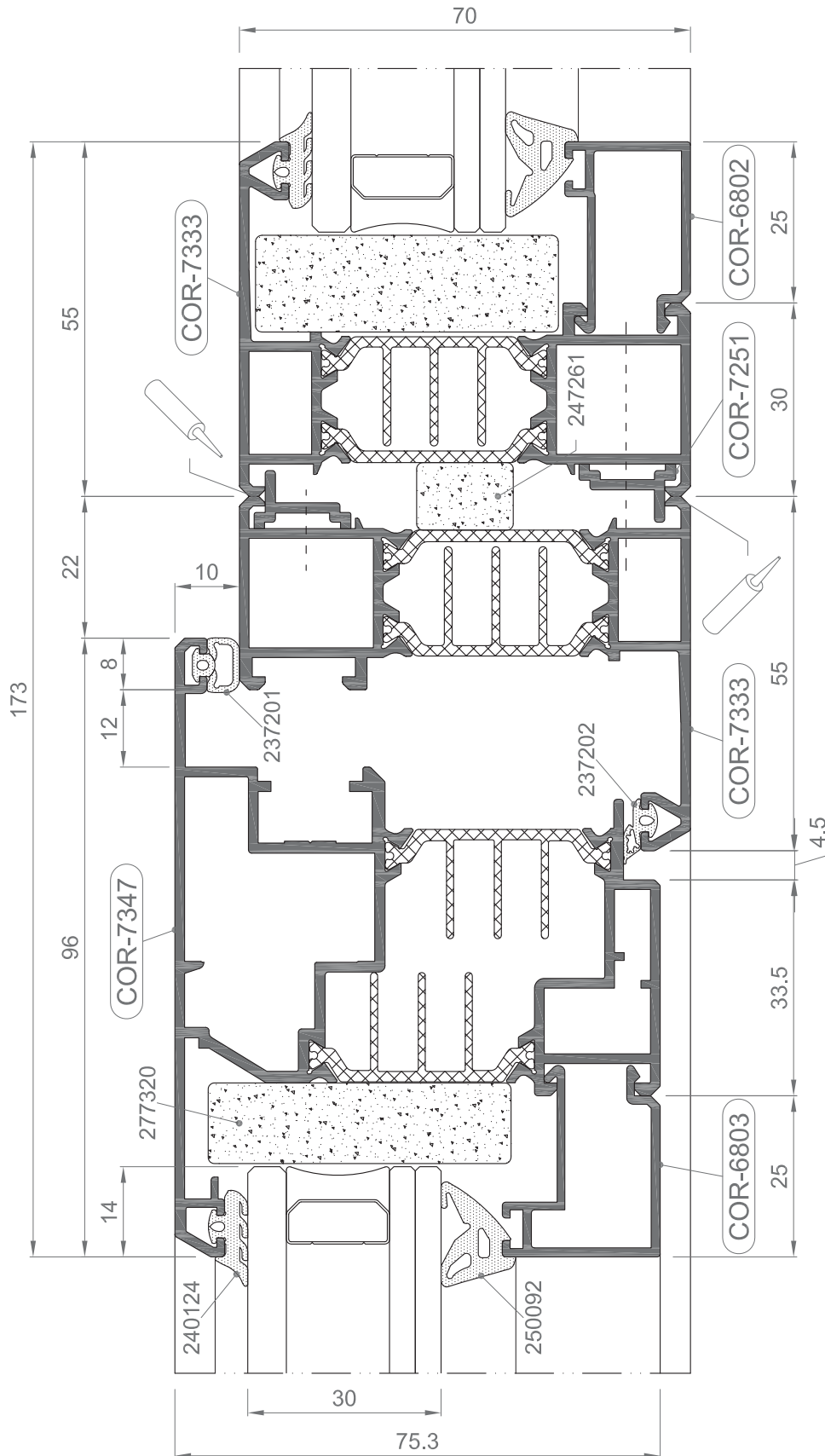

COR 70 CC16

Nudos constructivos

E 1:1

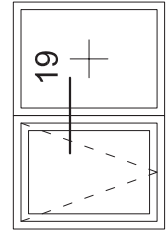
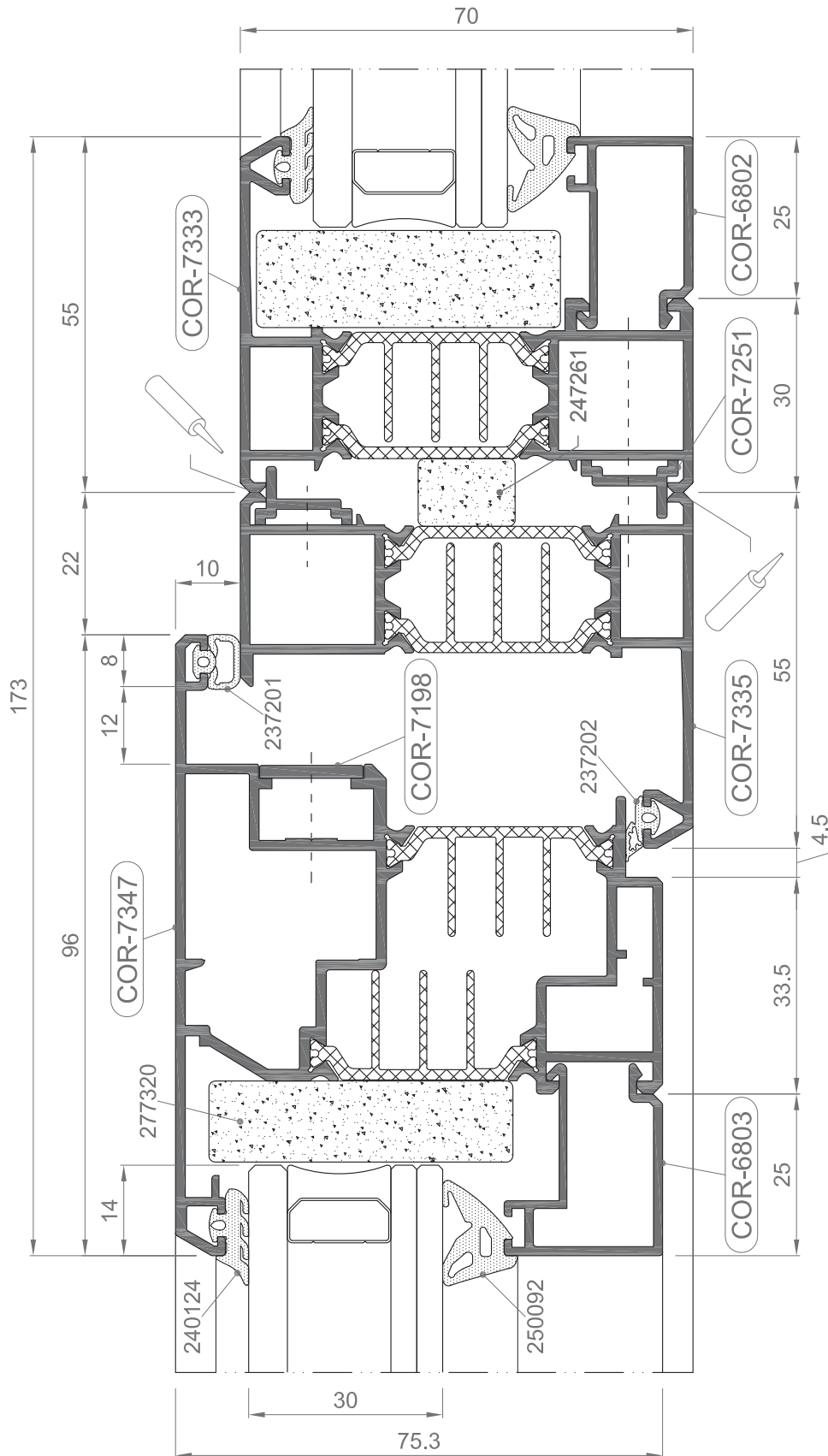

COR 70 CC16

Nudos constructivos

E 1:1

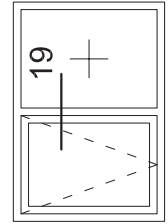
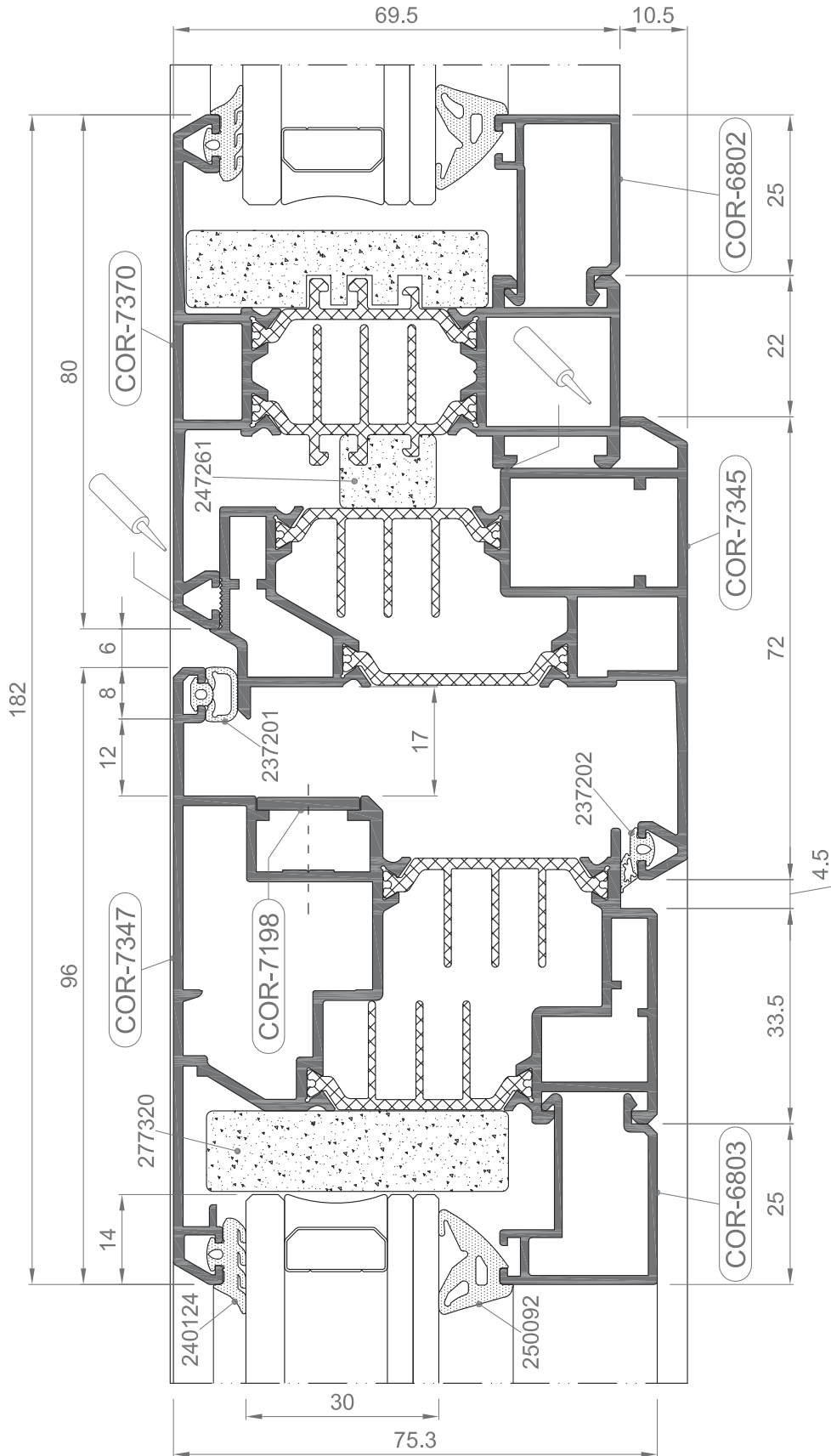

E 1:1

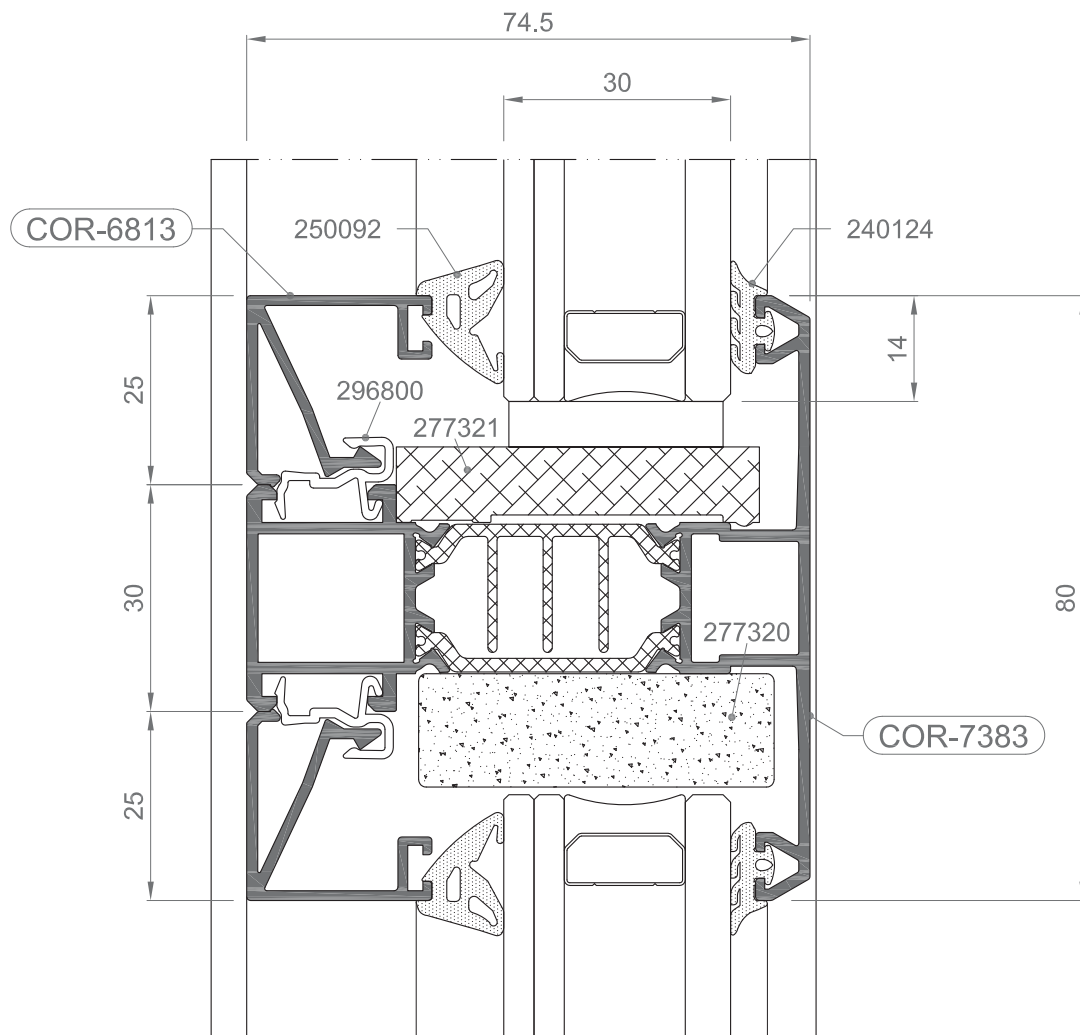
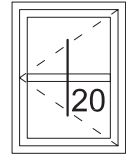

E 1:1

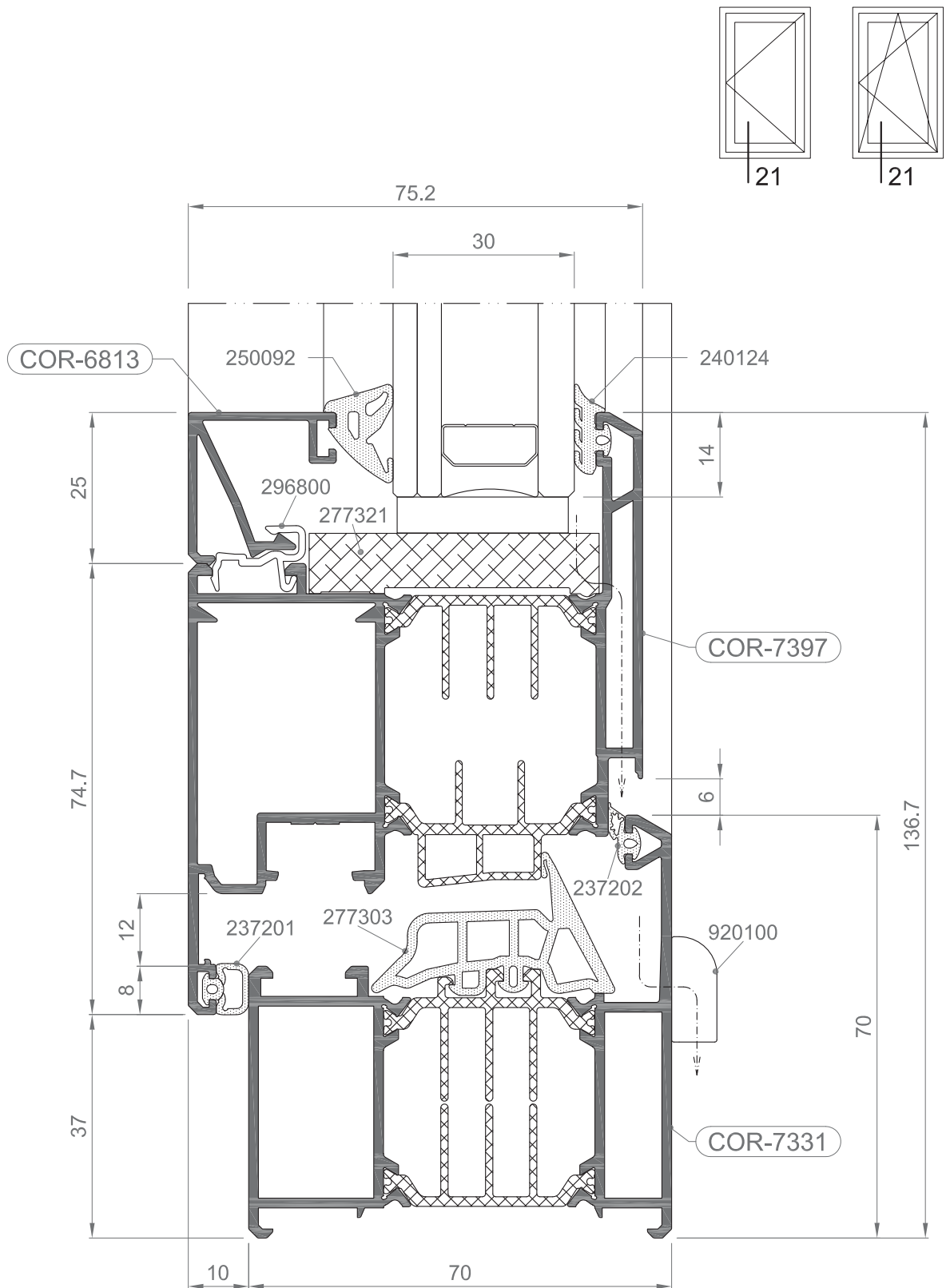

E 1:1

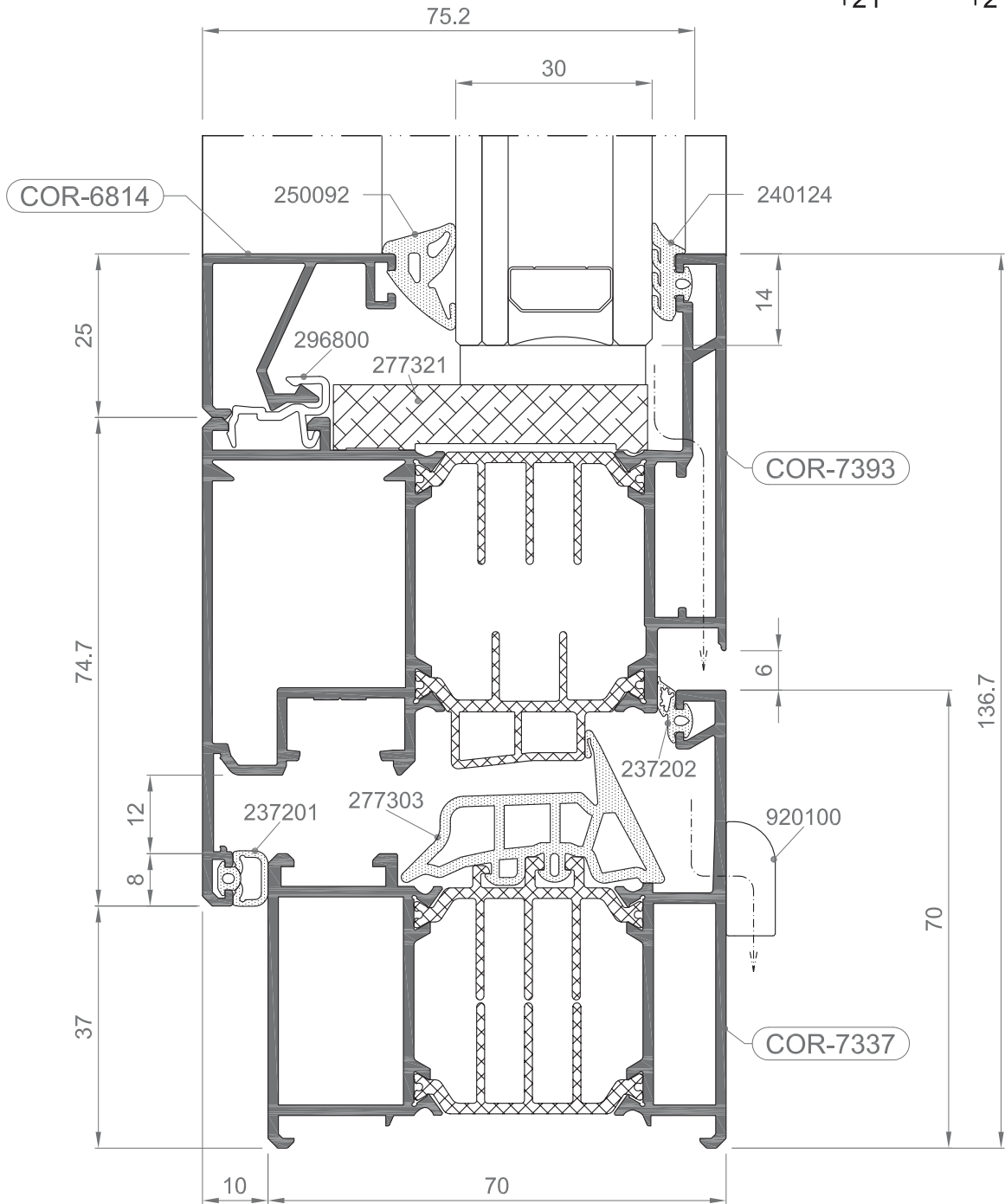
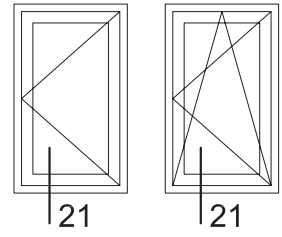

E 1:1

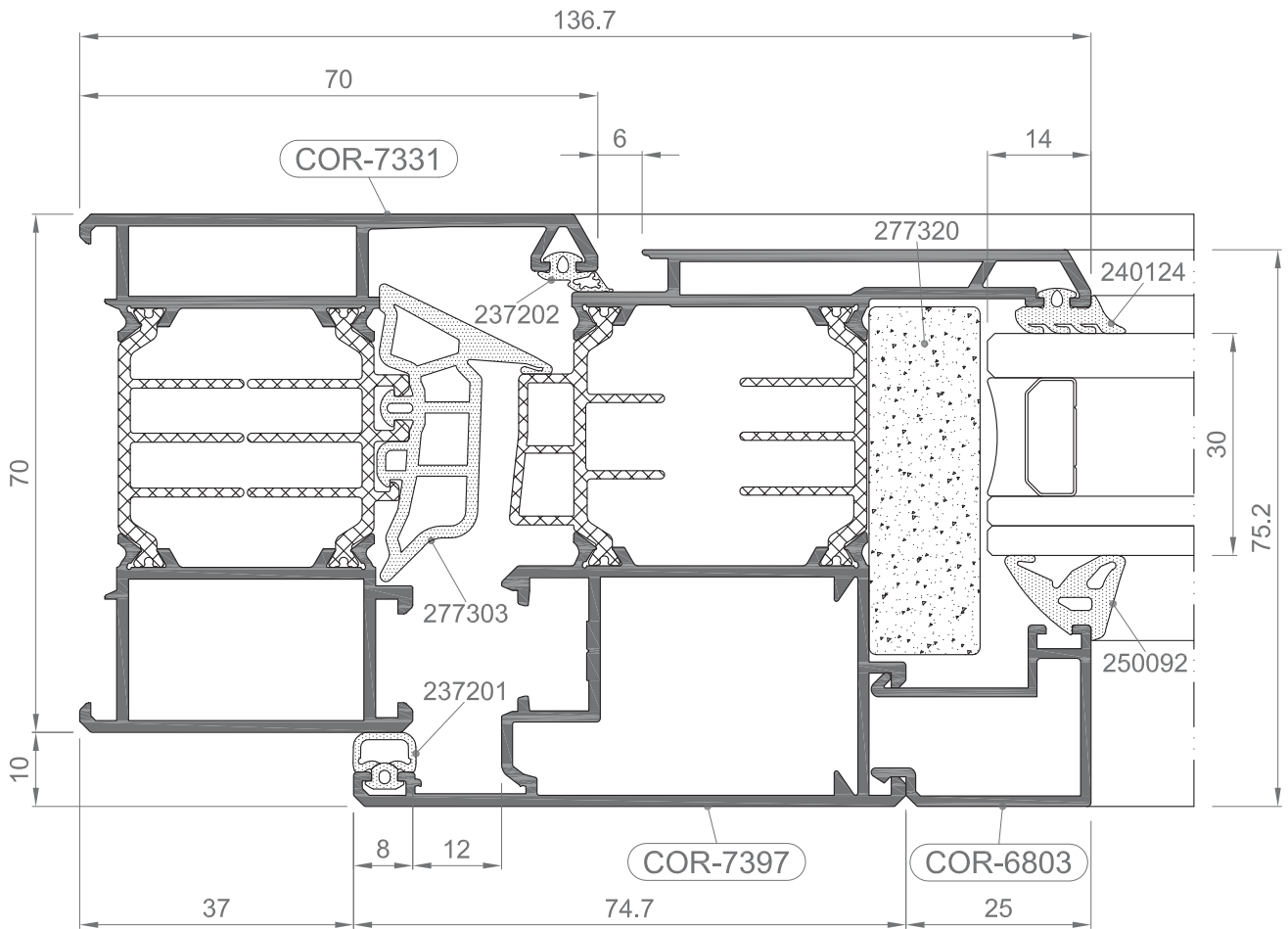
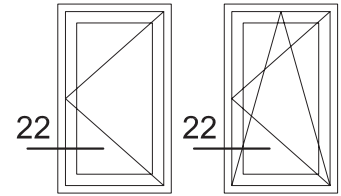

E 1:1

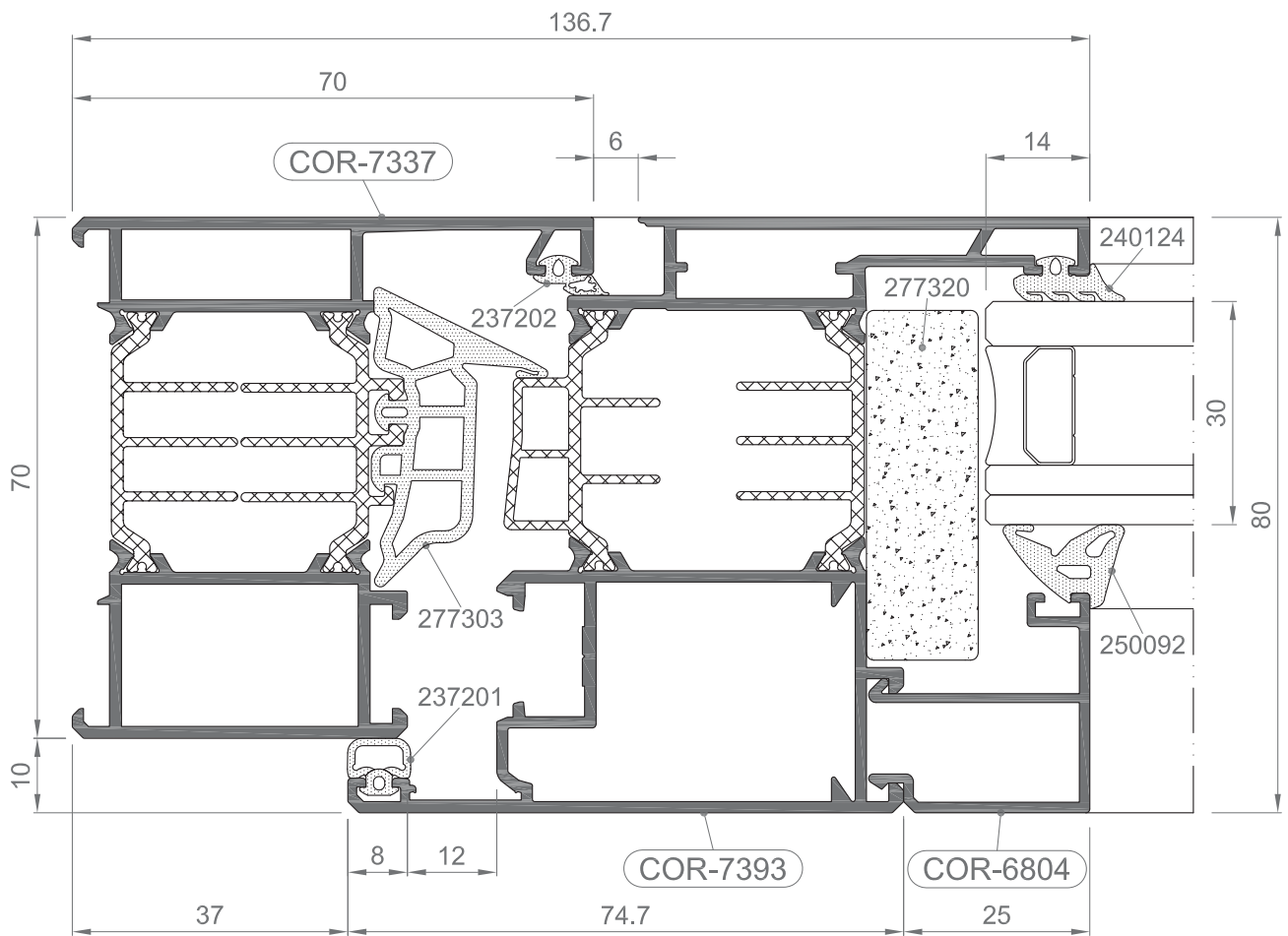
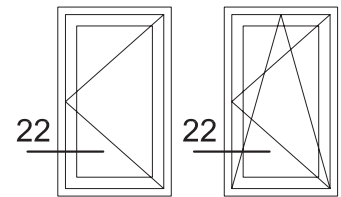

COR 70 CC16

Nudos constructivos

E 1:1

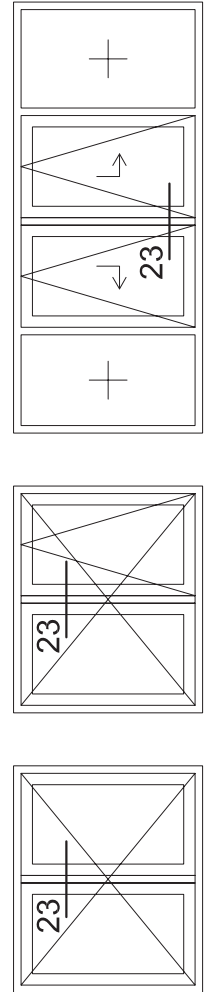
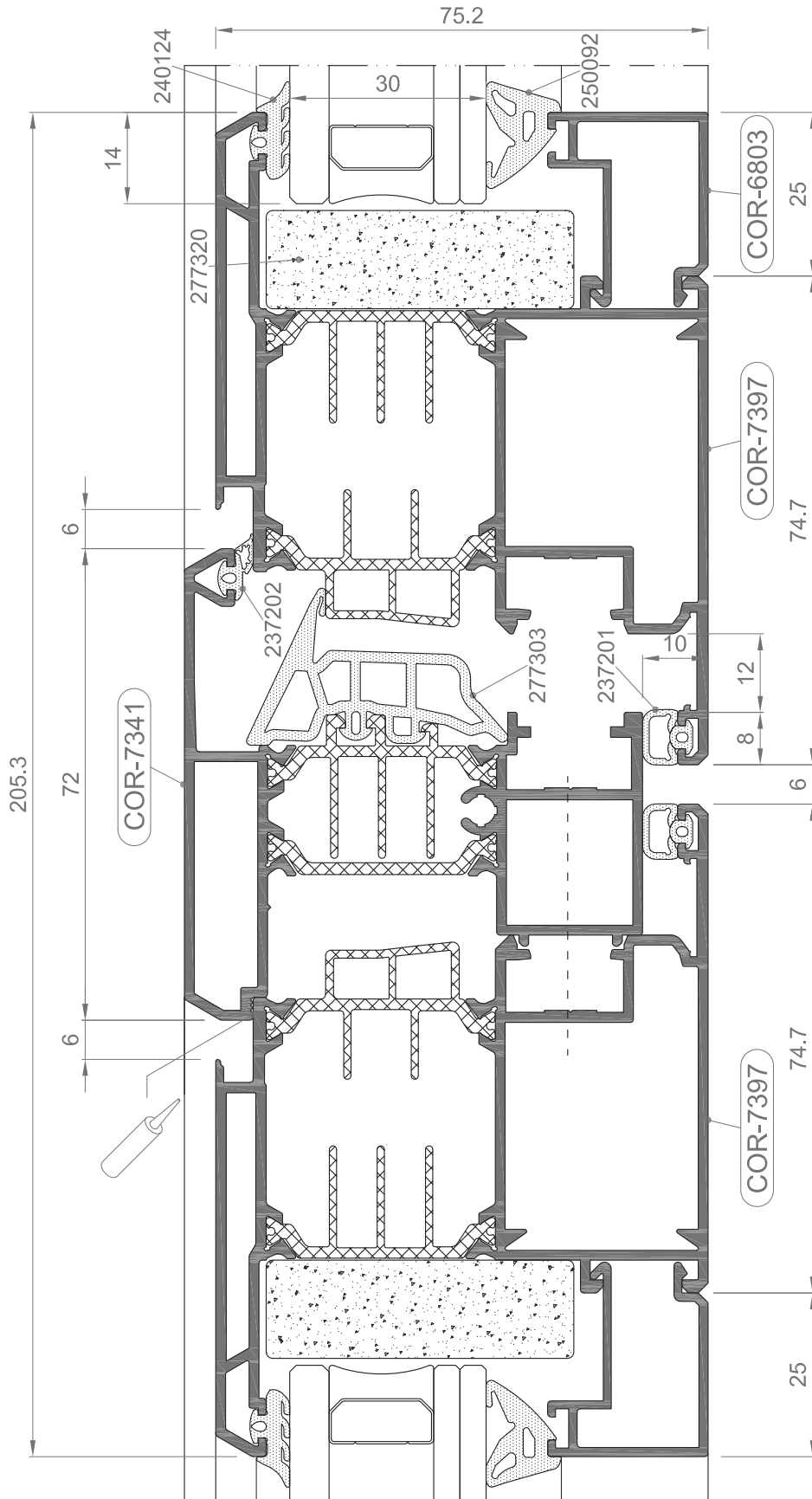

COR 70 CC16

Nudos constructivos

E 1:1

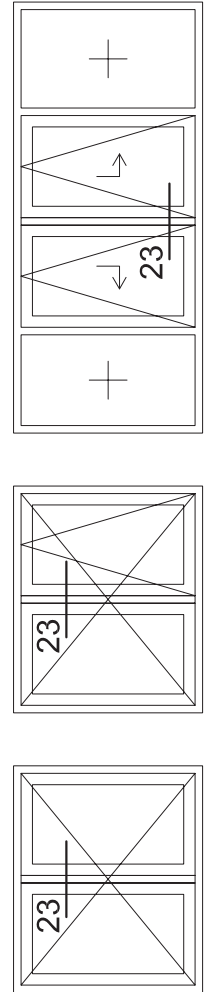
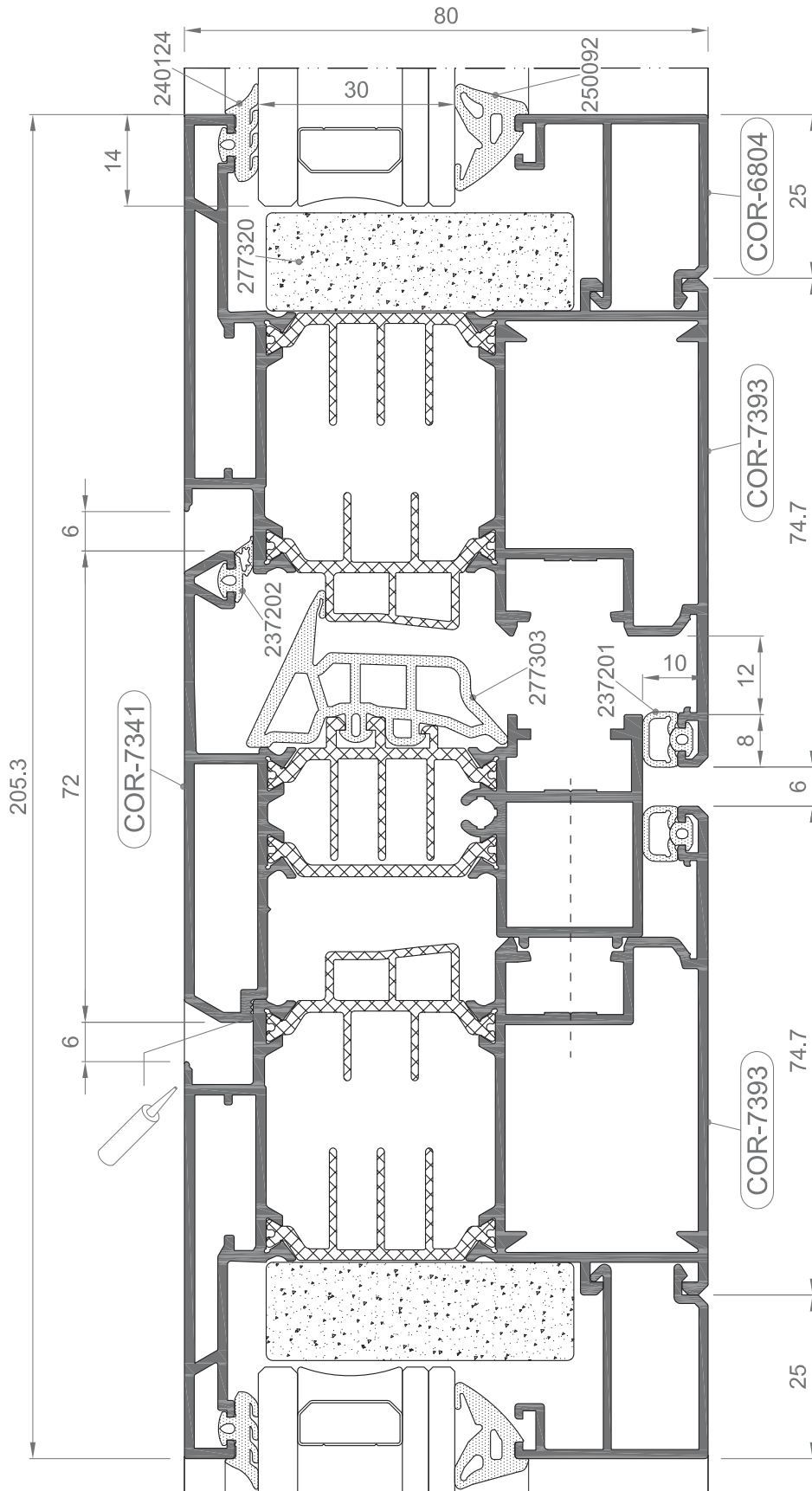

COR 70 CC16

Nudos constructivos

E 1:1

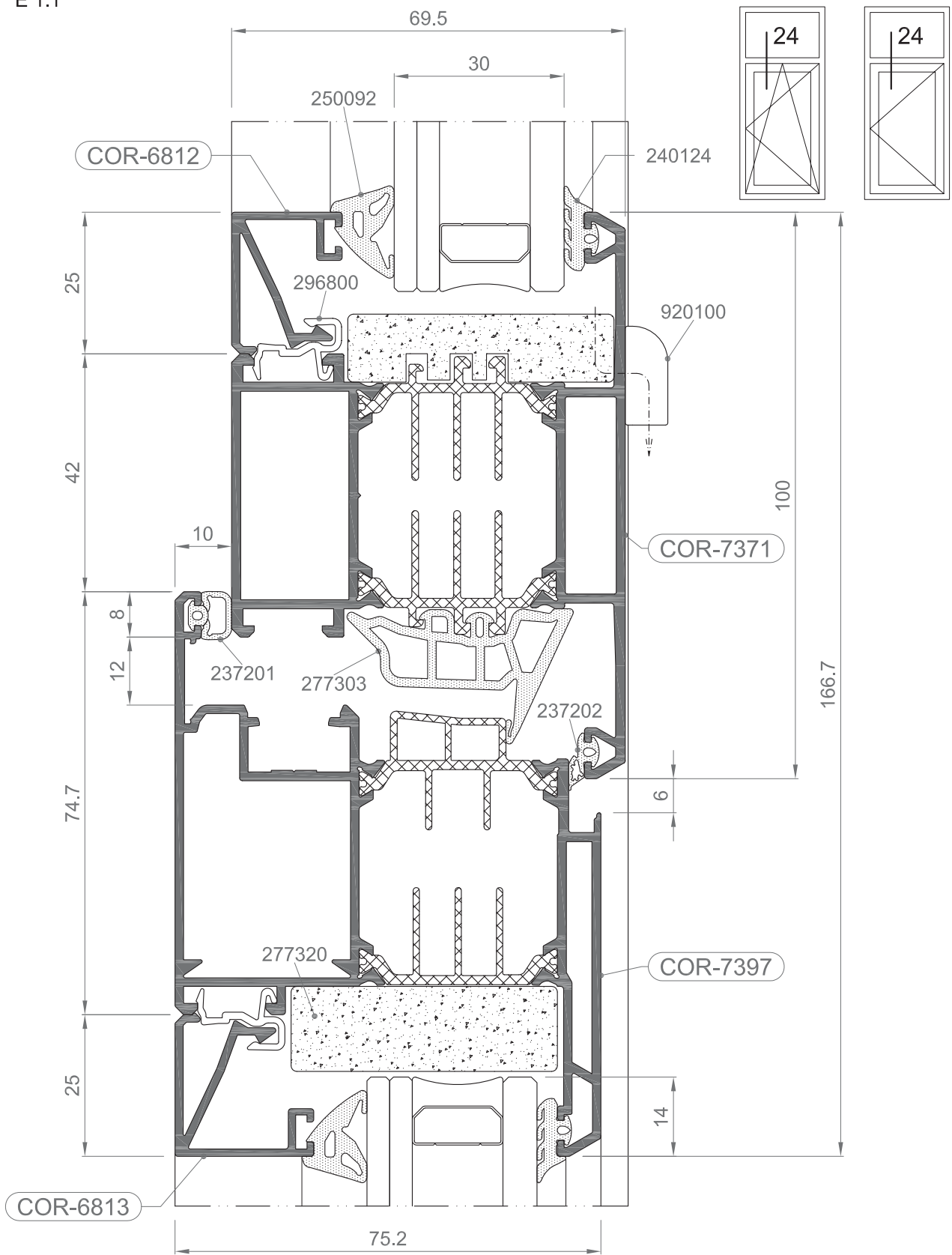

COR 70 CC16

Nudos constructivos

E 1:1

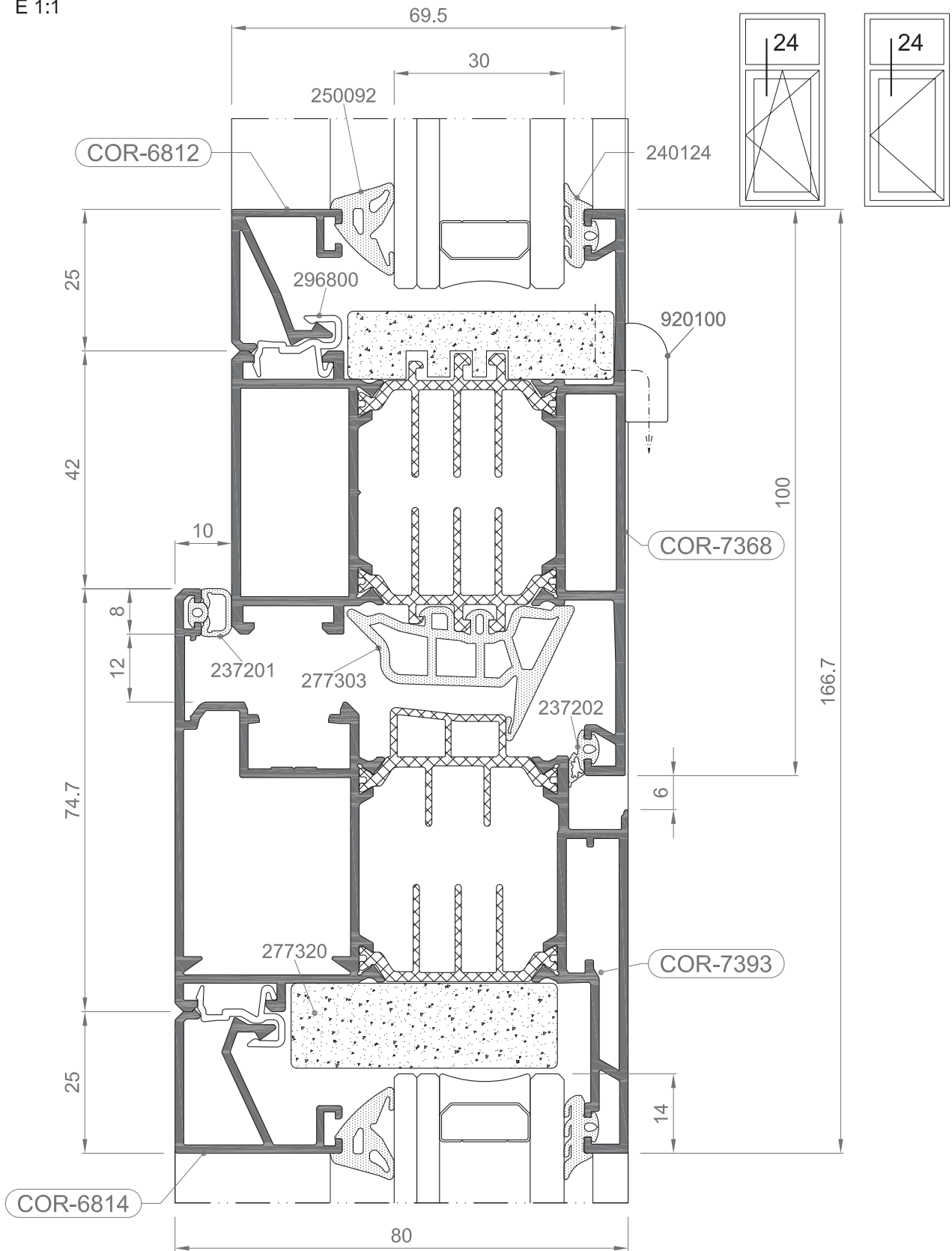

COR 70 CC16

Nudos constructivos

E 1:1

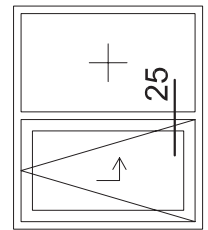
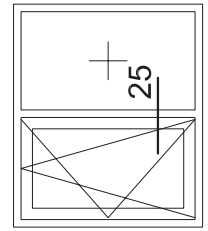
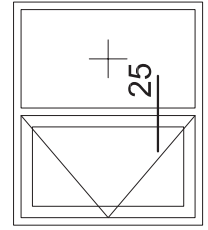
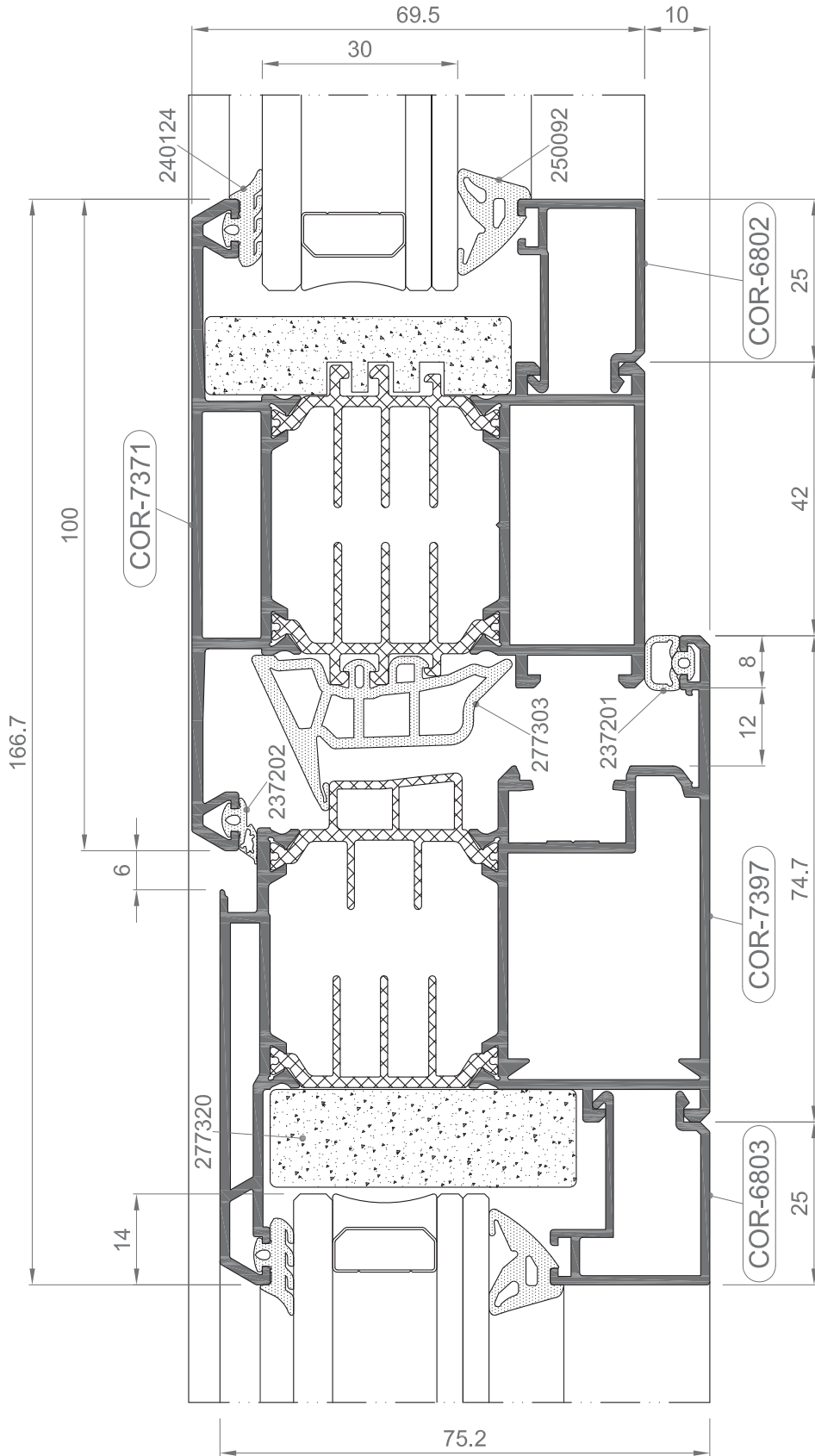

E 1:1

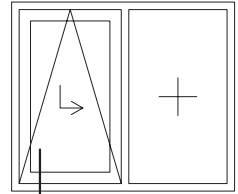

26

100 Kgs.

160 Kgs.

200 Kgs.

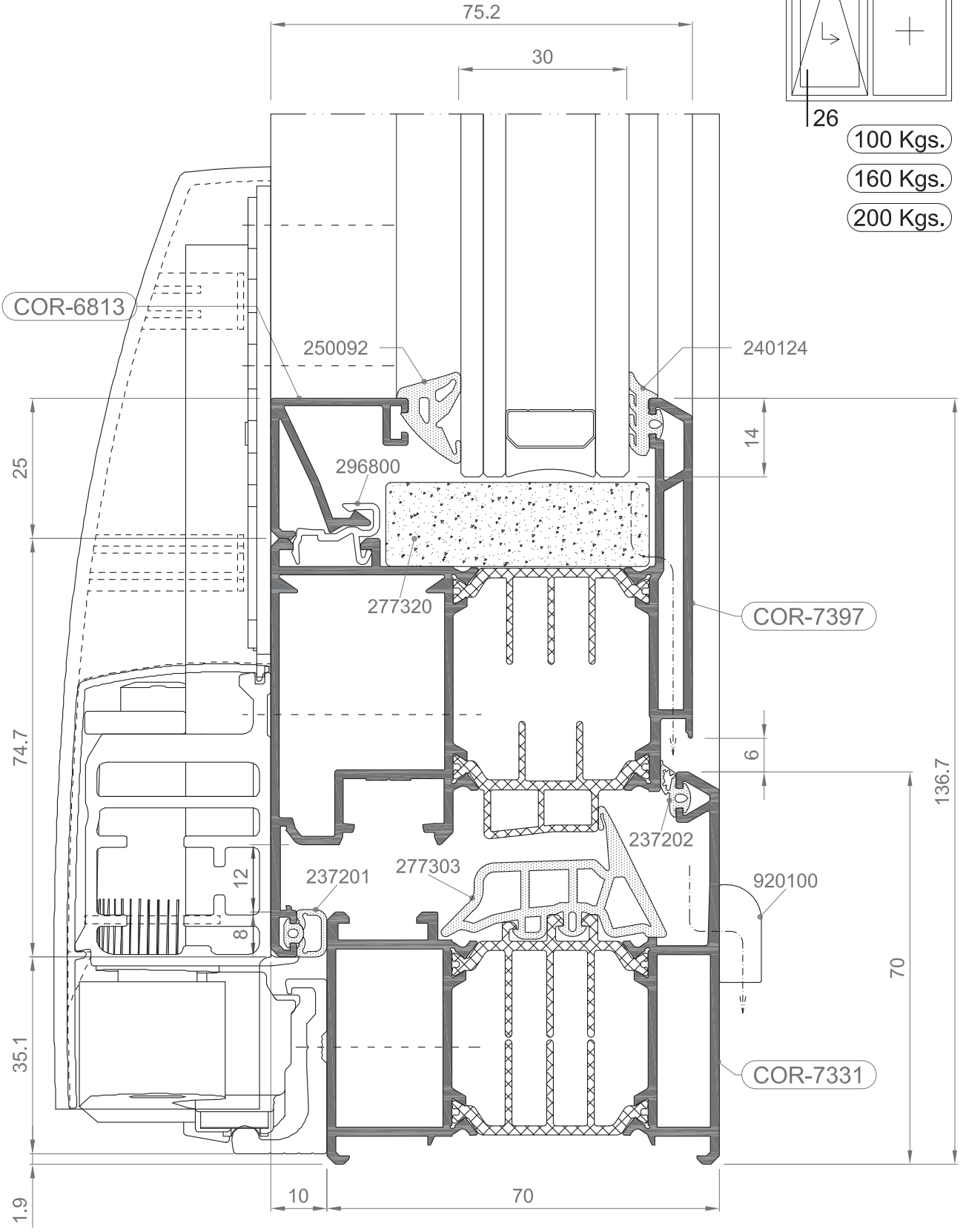

COR 70 CC16

Nudos constructivos

E 1:1

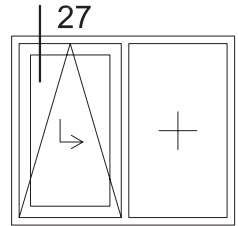

100 Kgs.

160 Kgs.

200 Kgs.

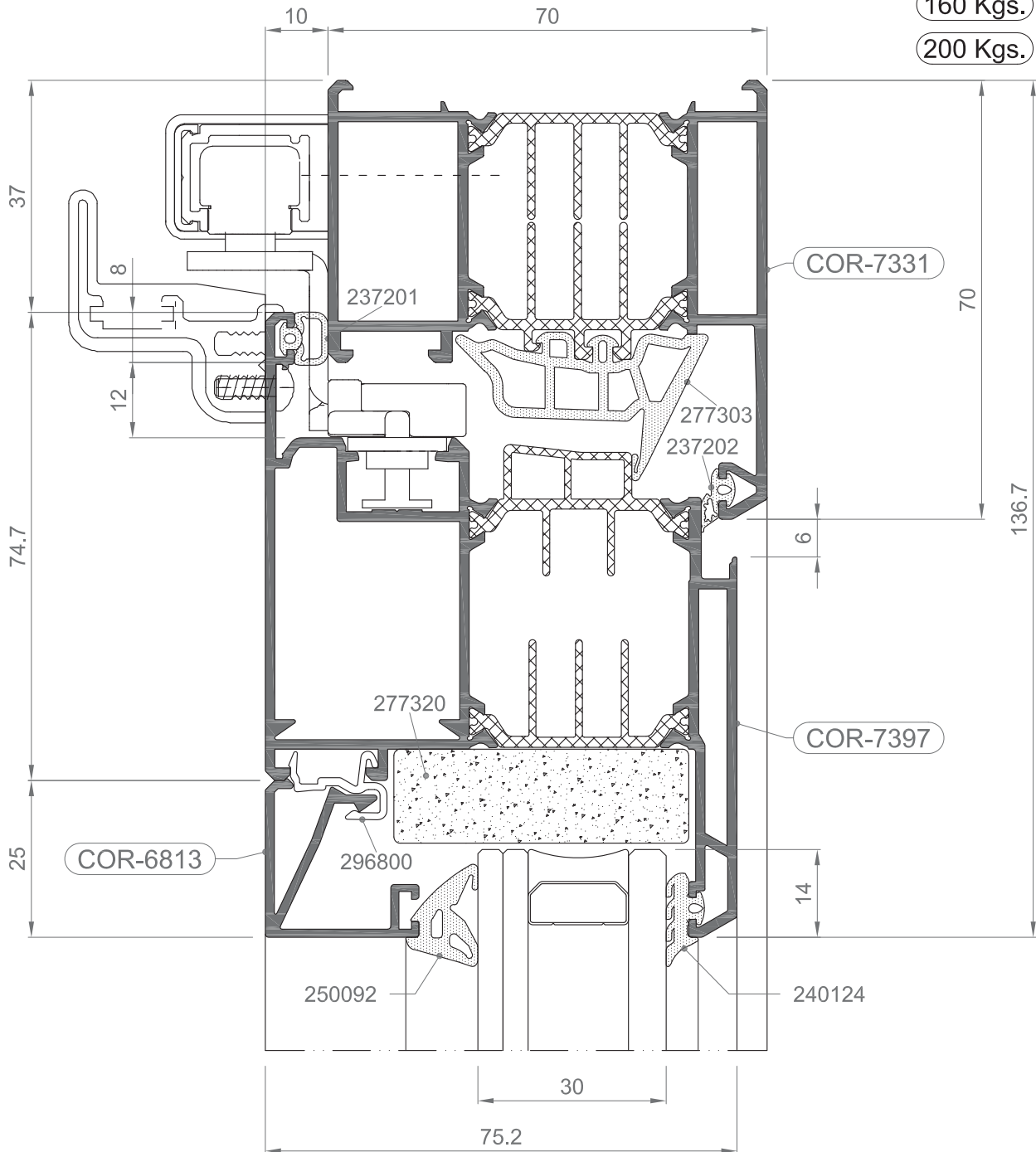

E 1:1

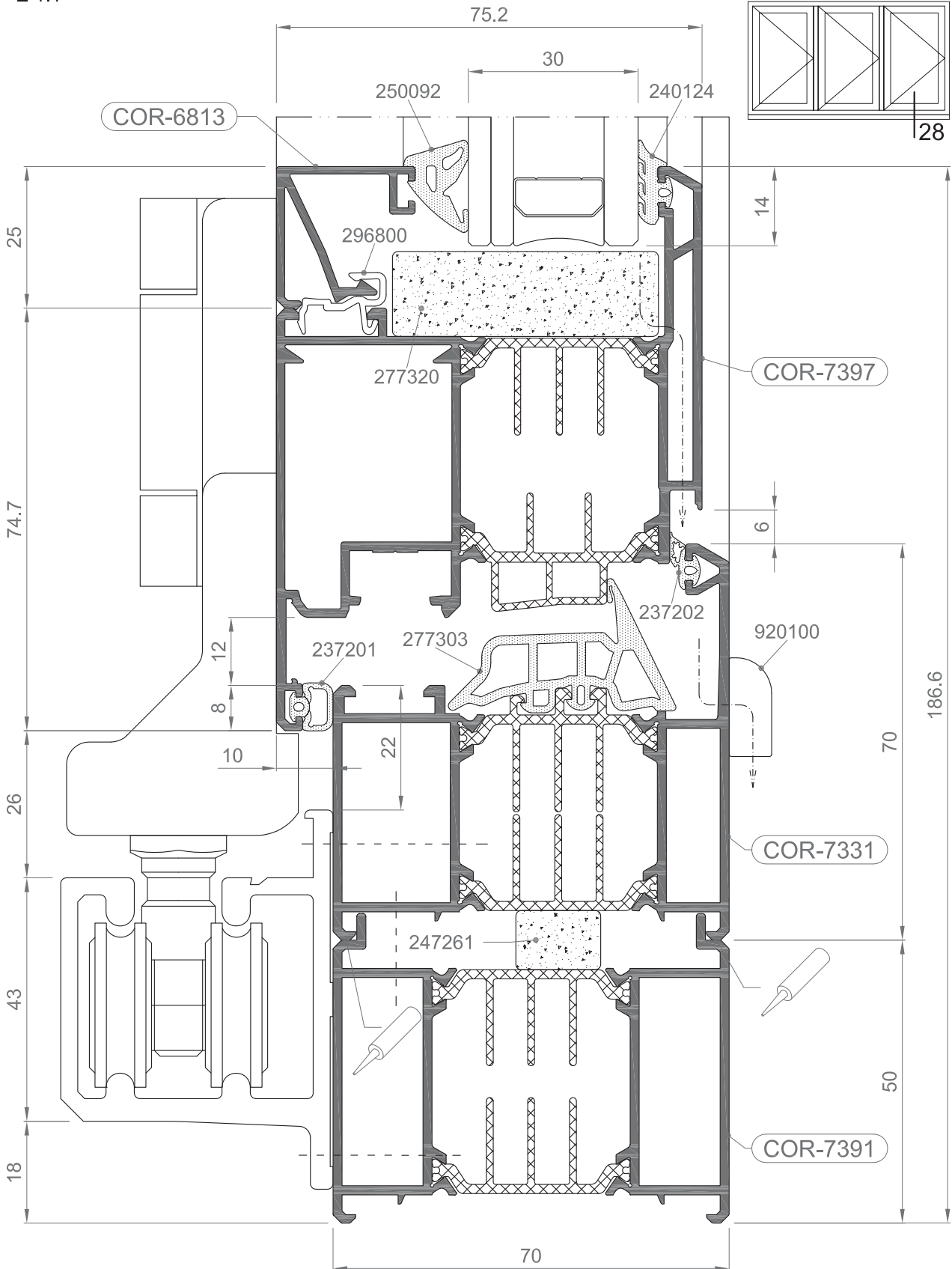

COR 70 CC16

Nudos constructivos

E 1:1

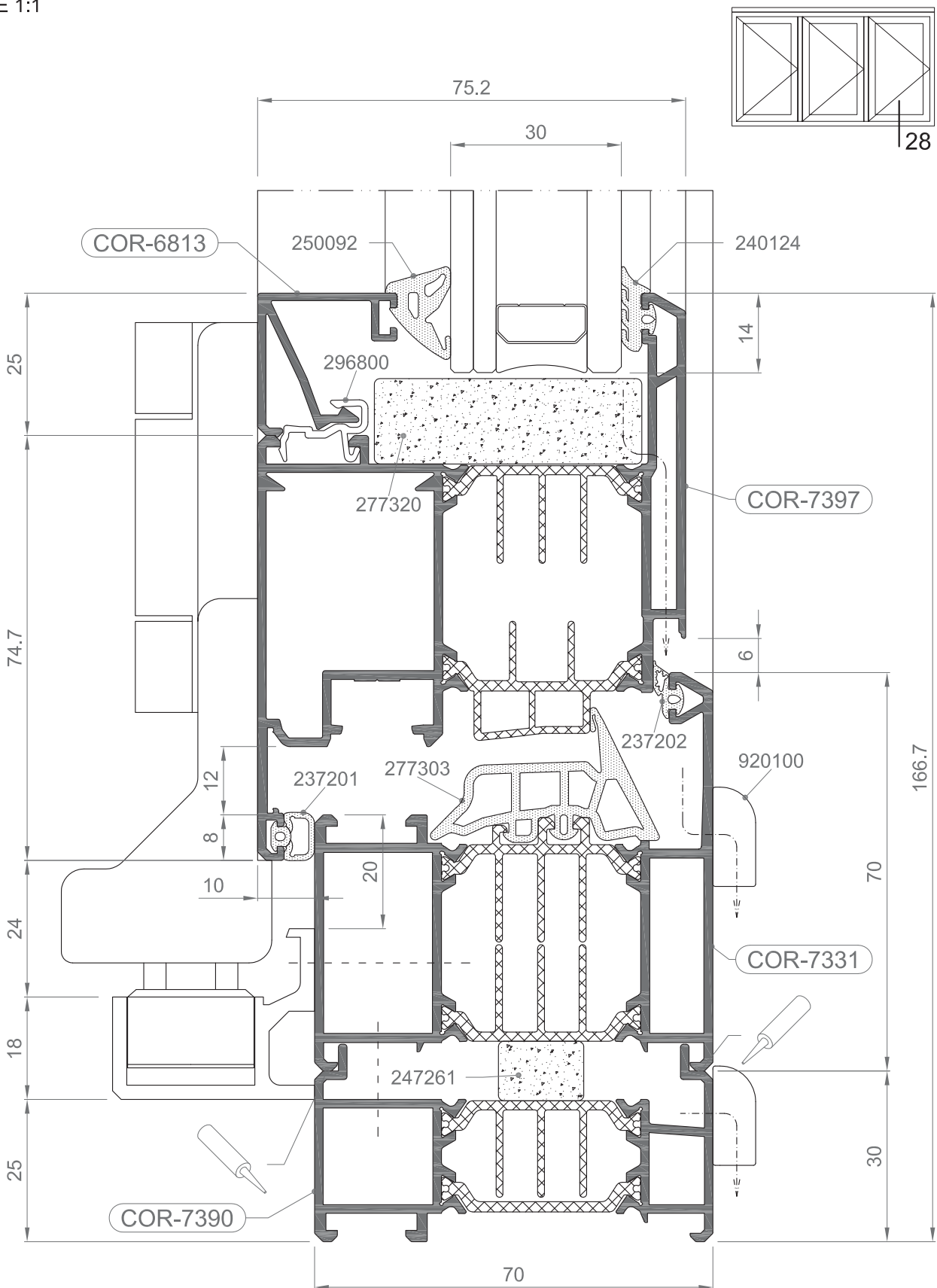

E 1:1

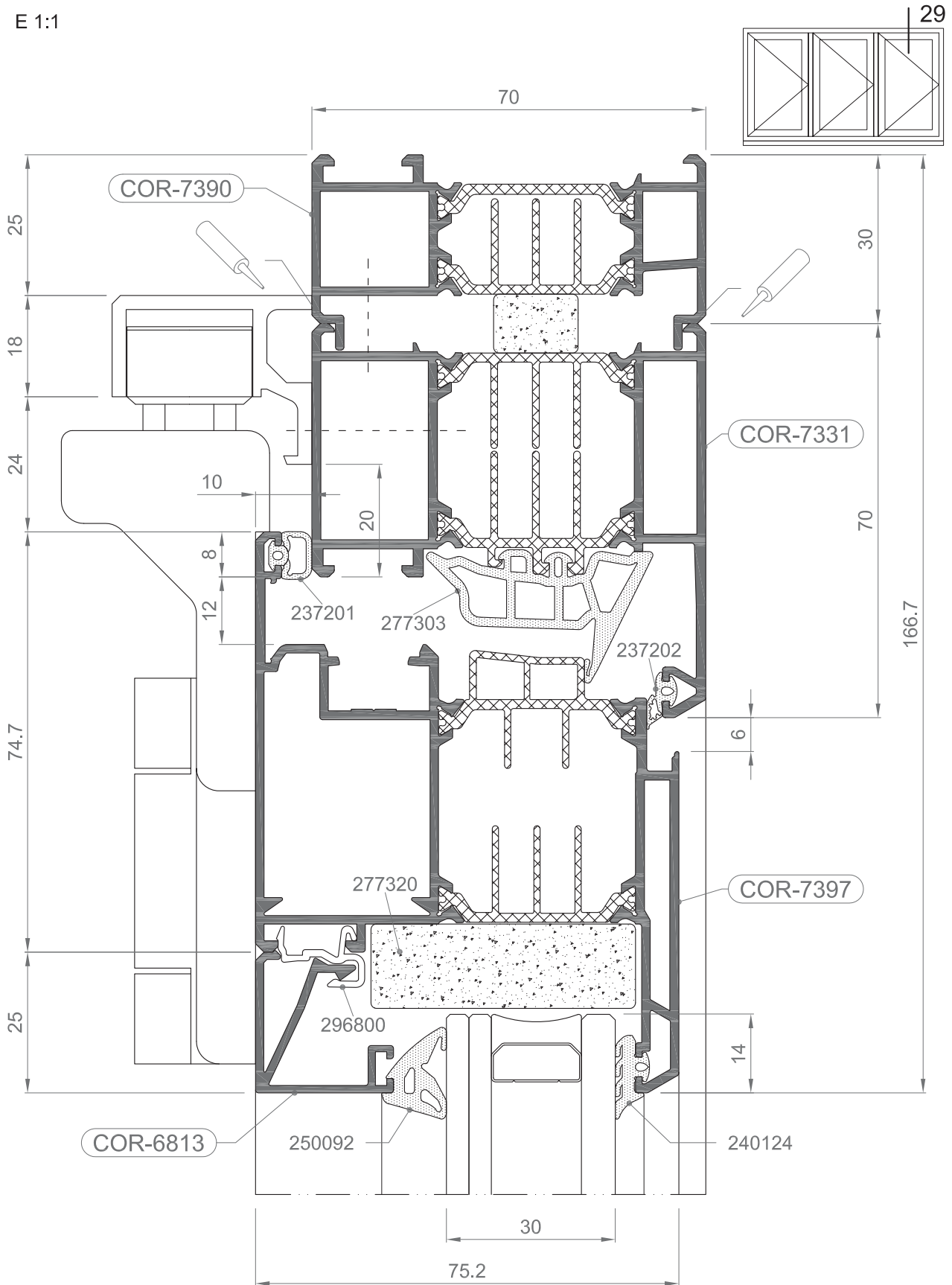

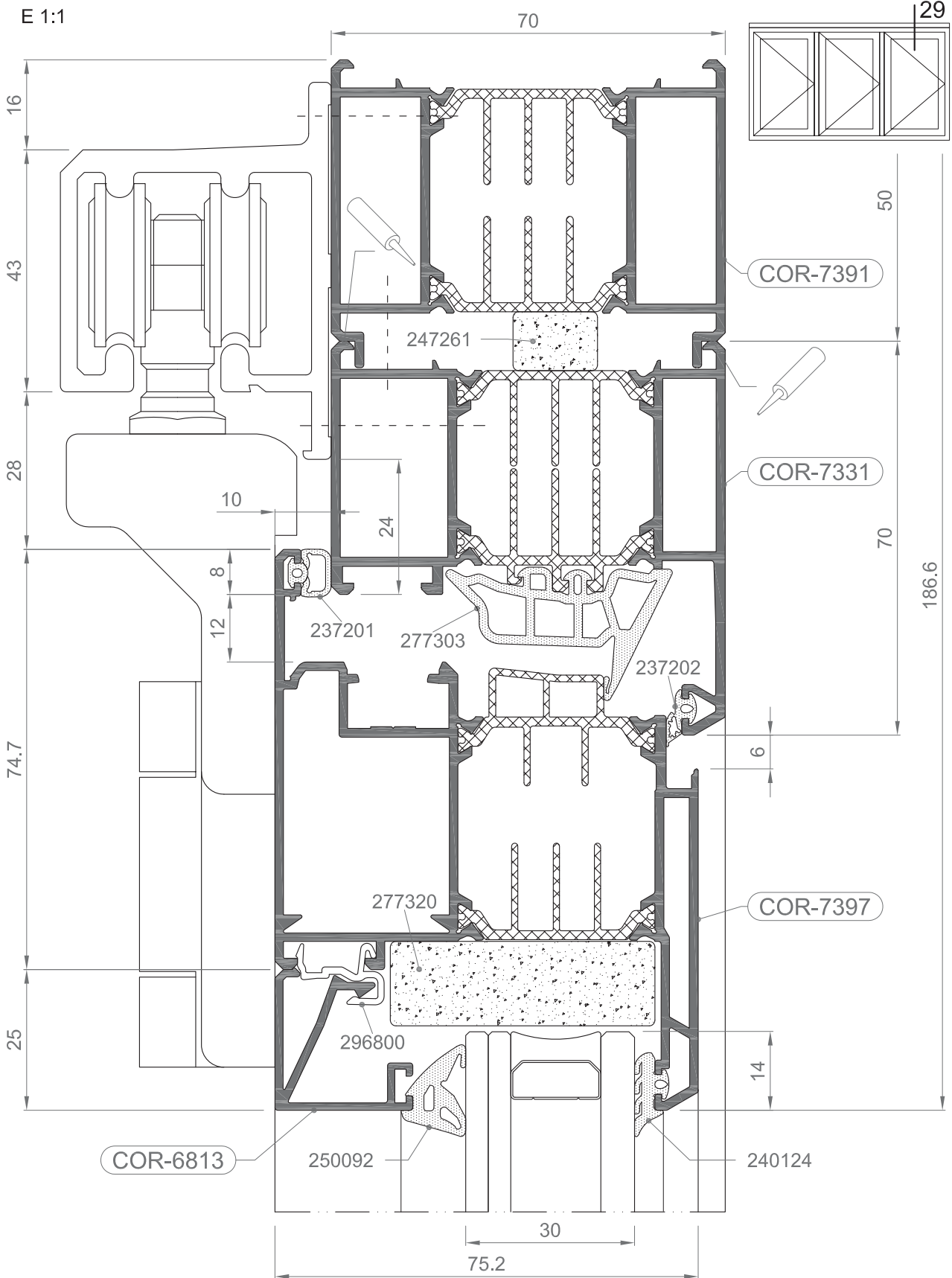

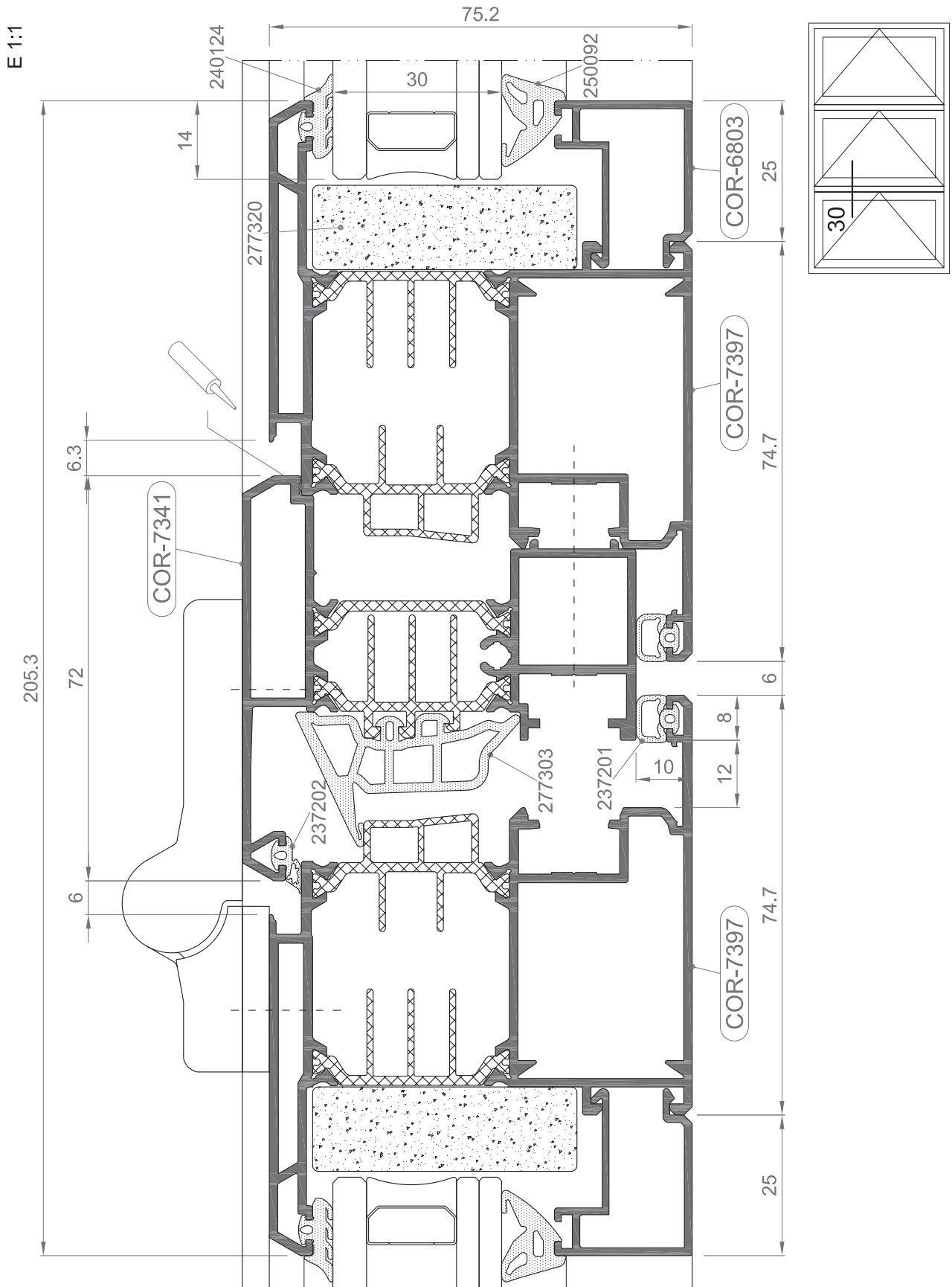

COR 70 CC16

Nudos constructivos

E 1:1

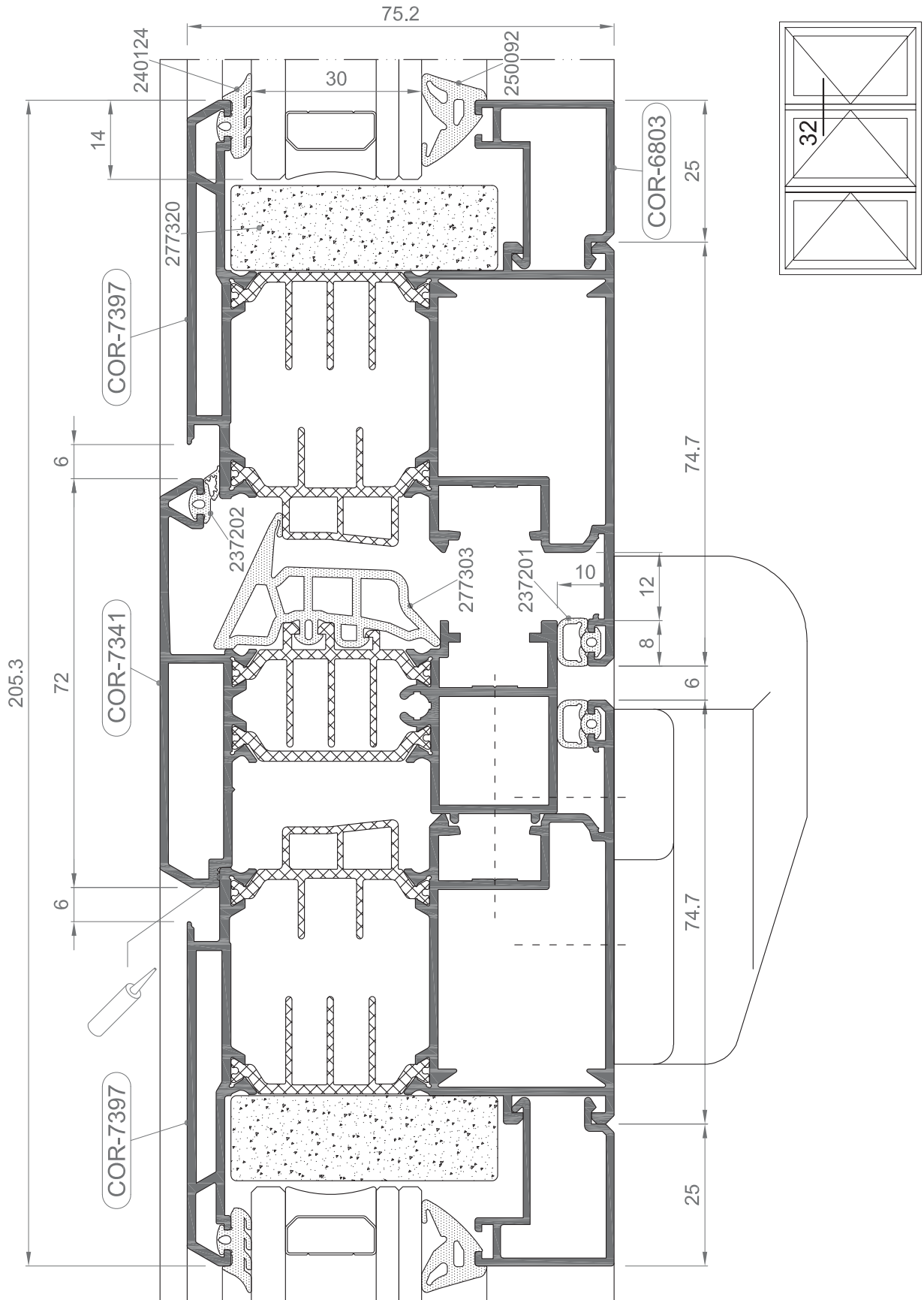

E 1:1

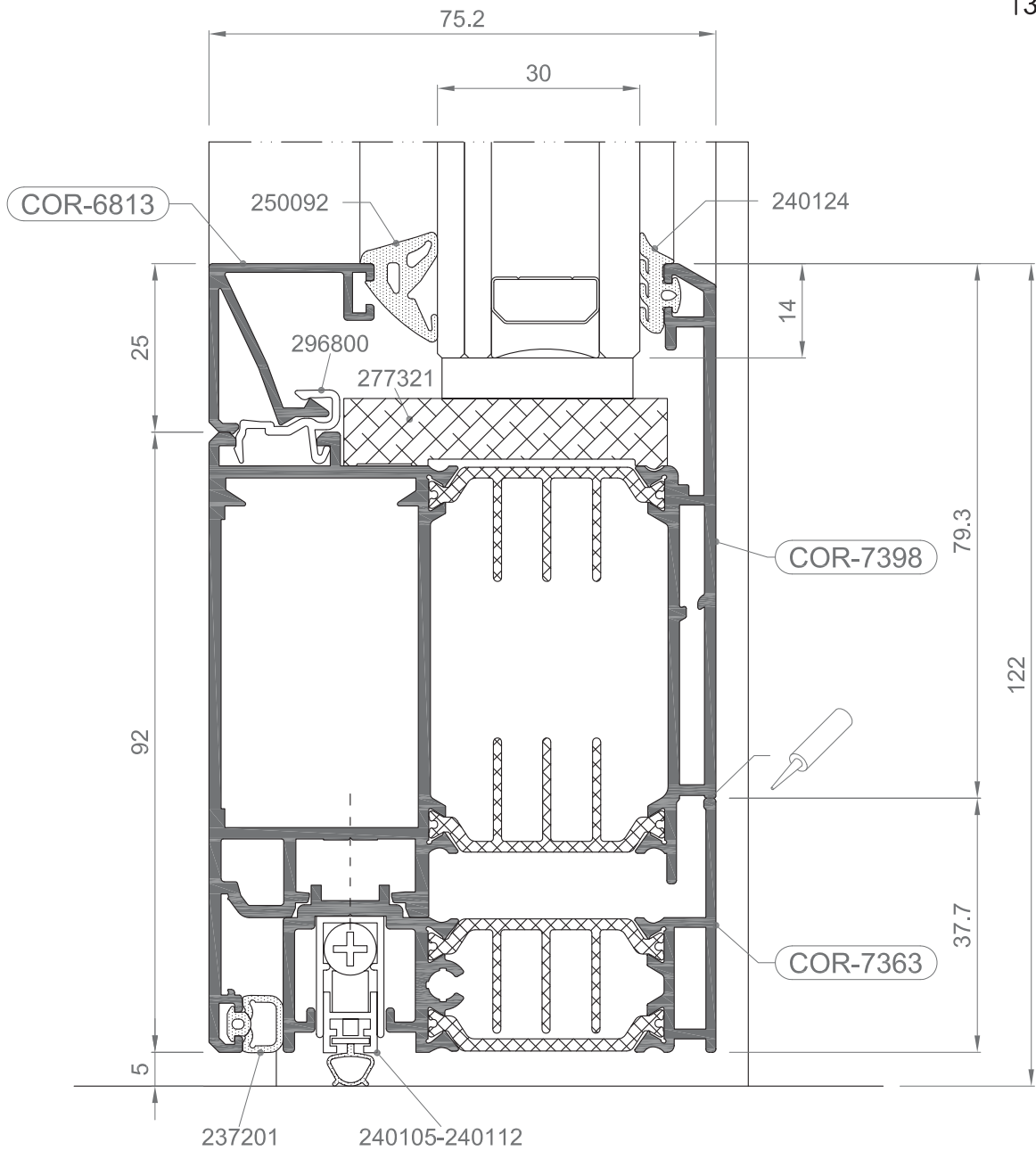
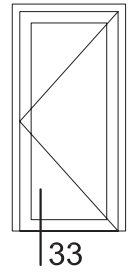

COR 70 CC16

Nudos constructivos

E 1:1

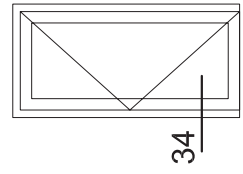
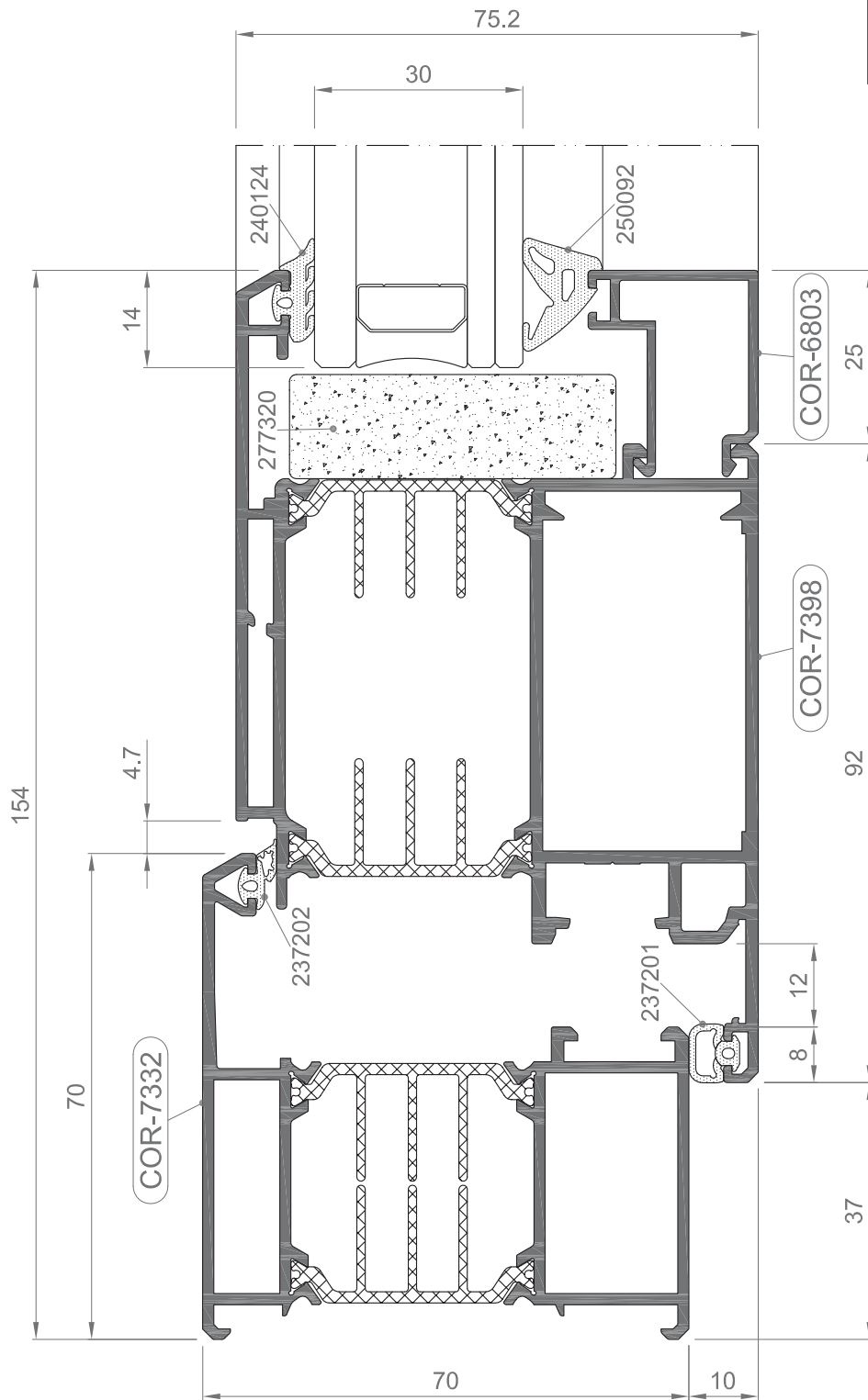

E 1:1

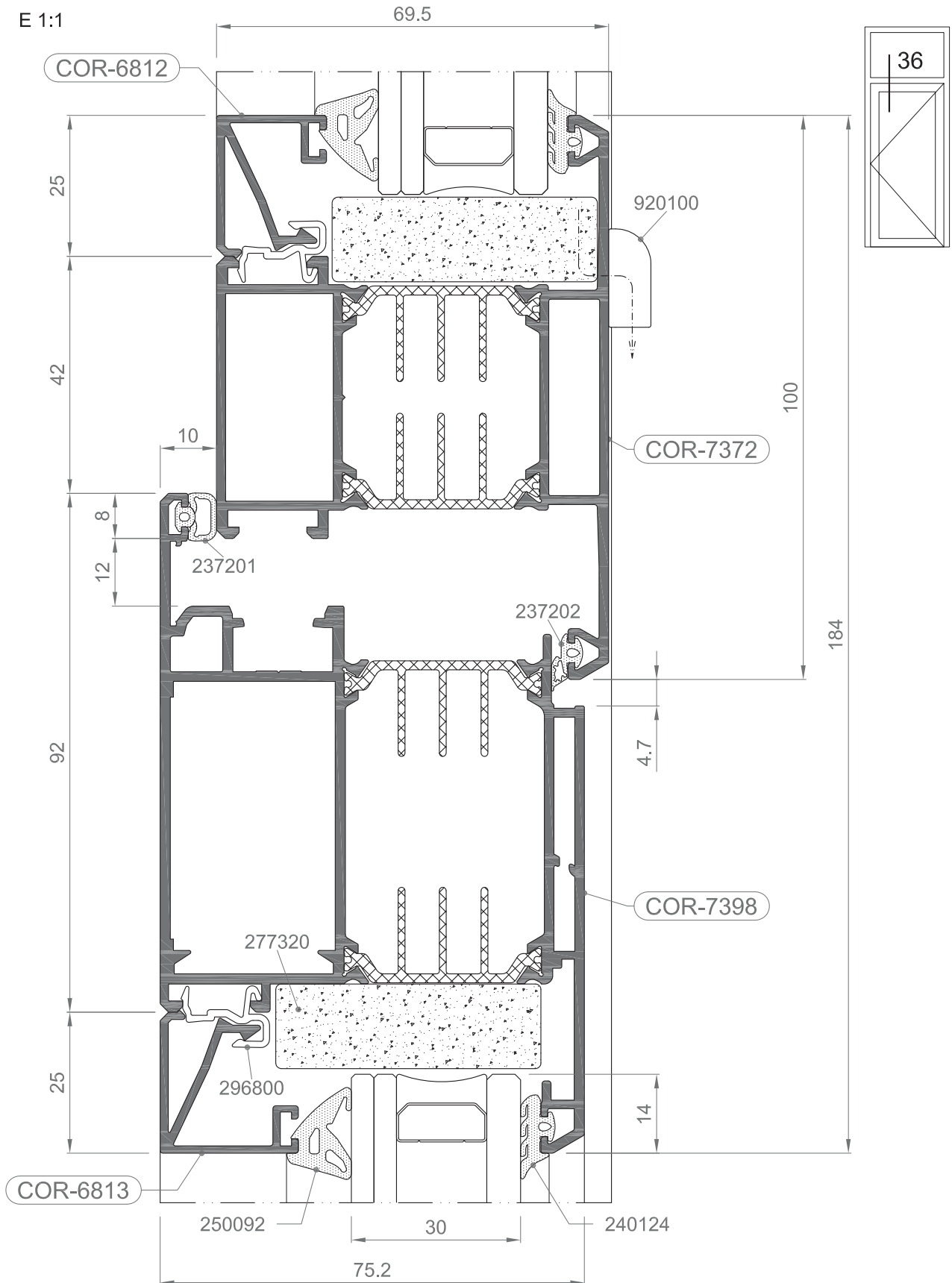

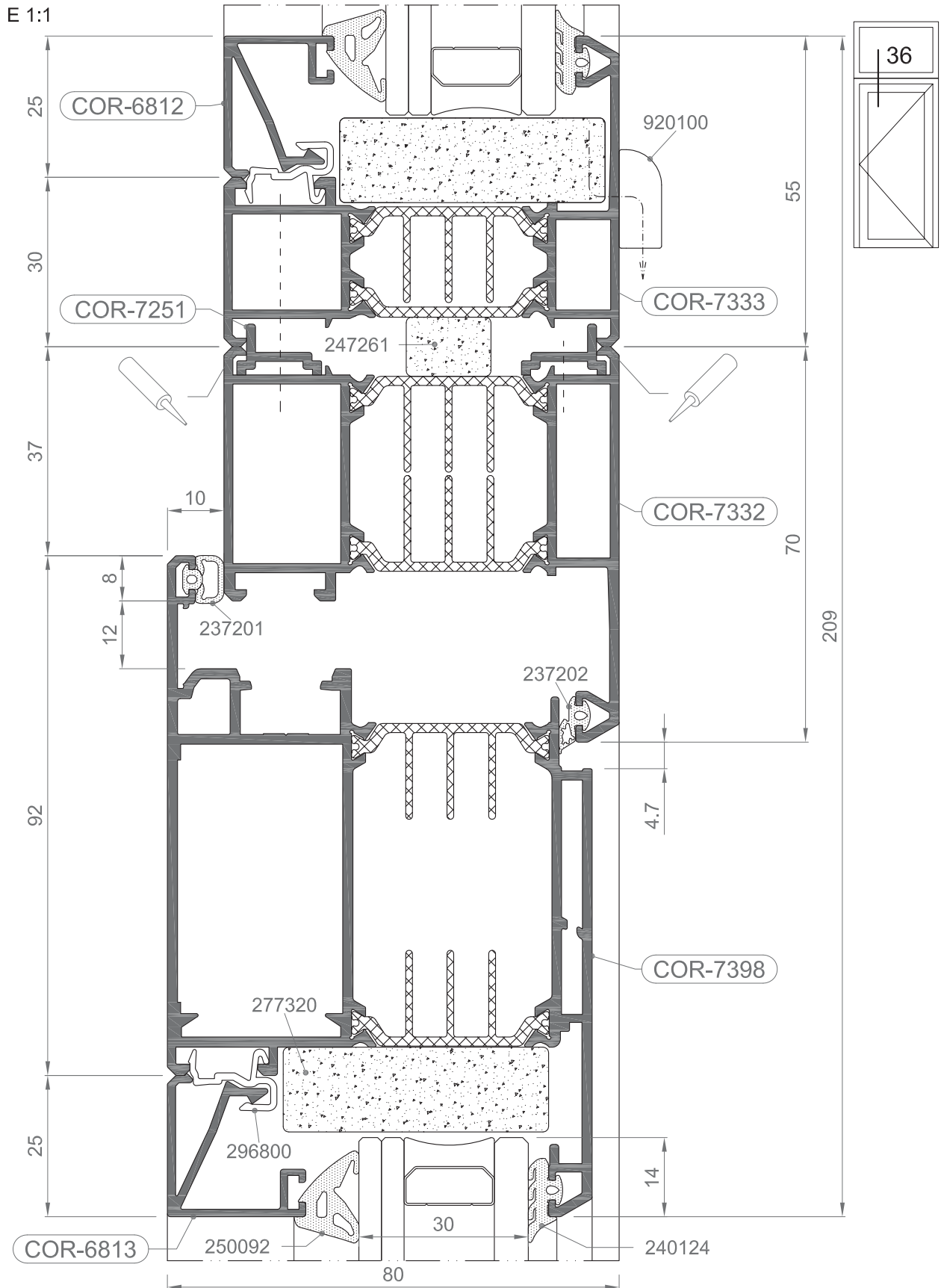

COR 70 CC16

Nudos constructivos

E 1:1

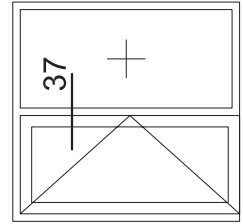
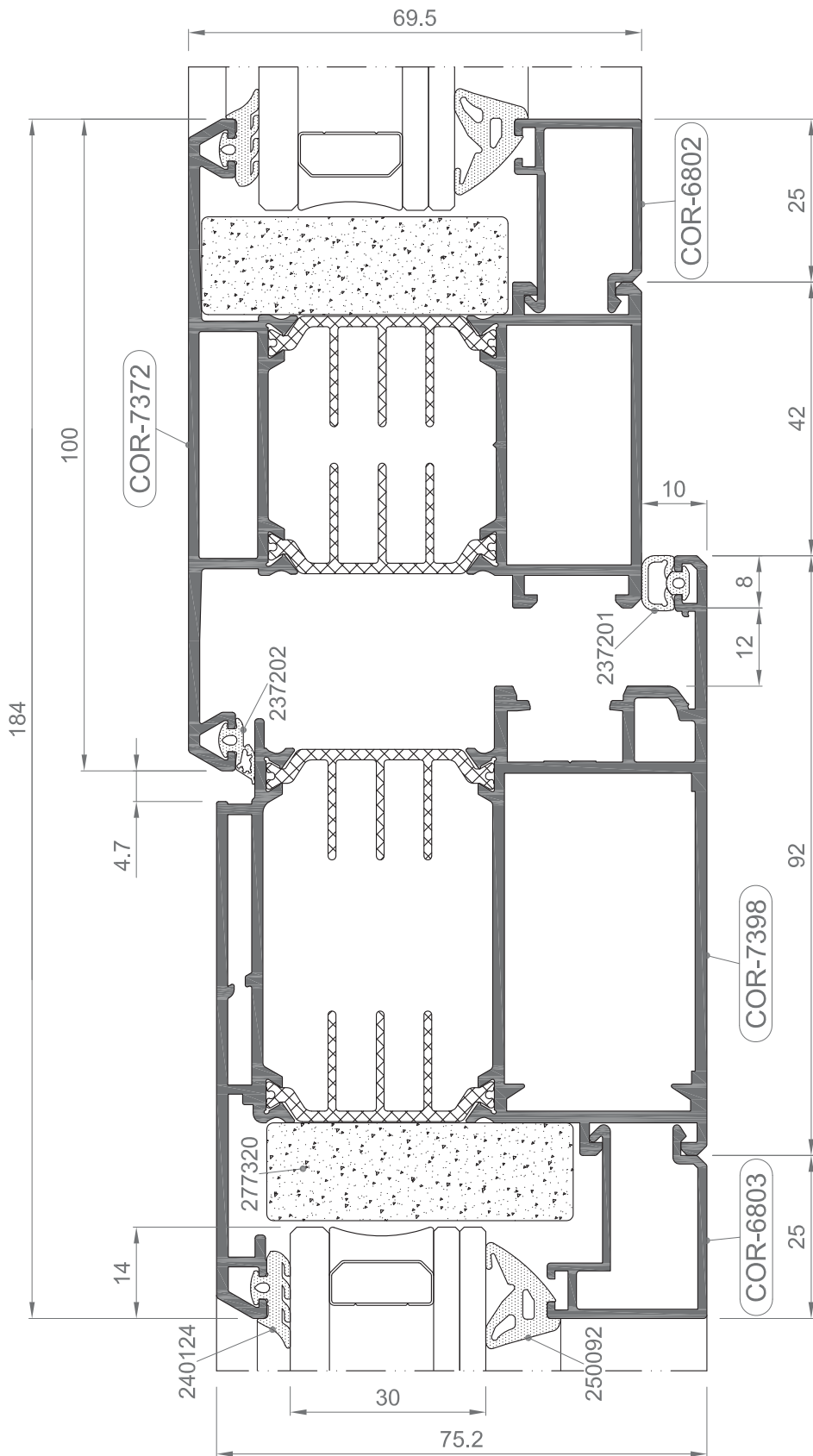

COR 70 CC16

Nudos constructivos

E 1:1

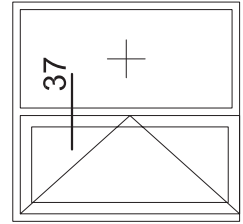
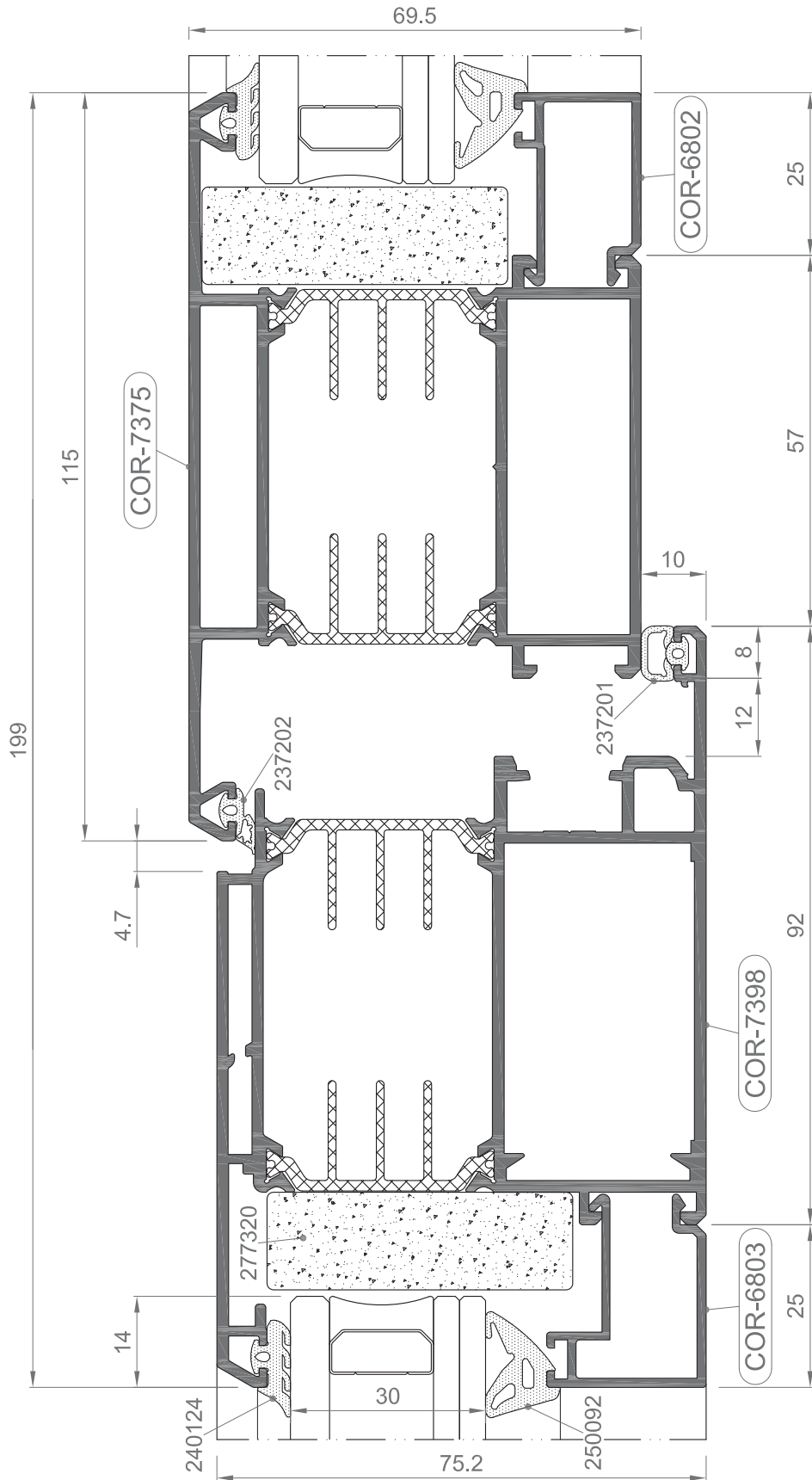

COR 70 CC16

Nudos constructivos

E 1:1

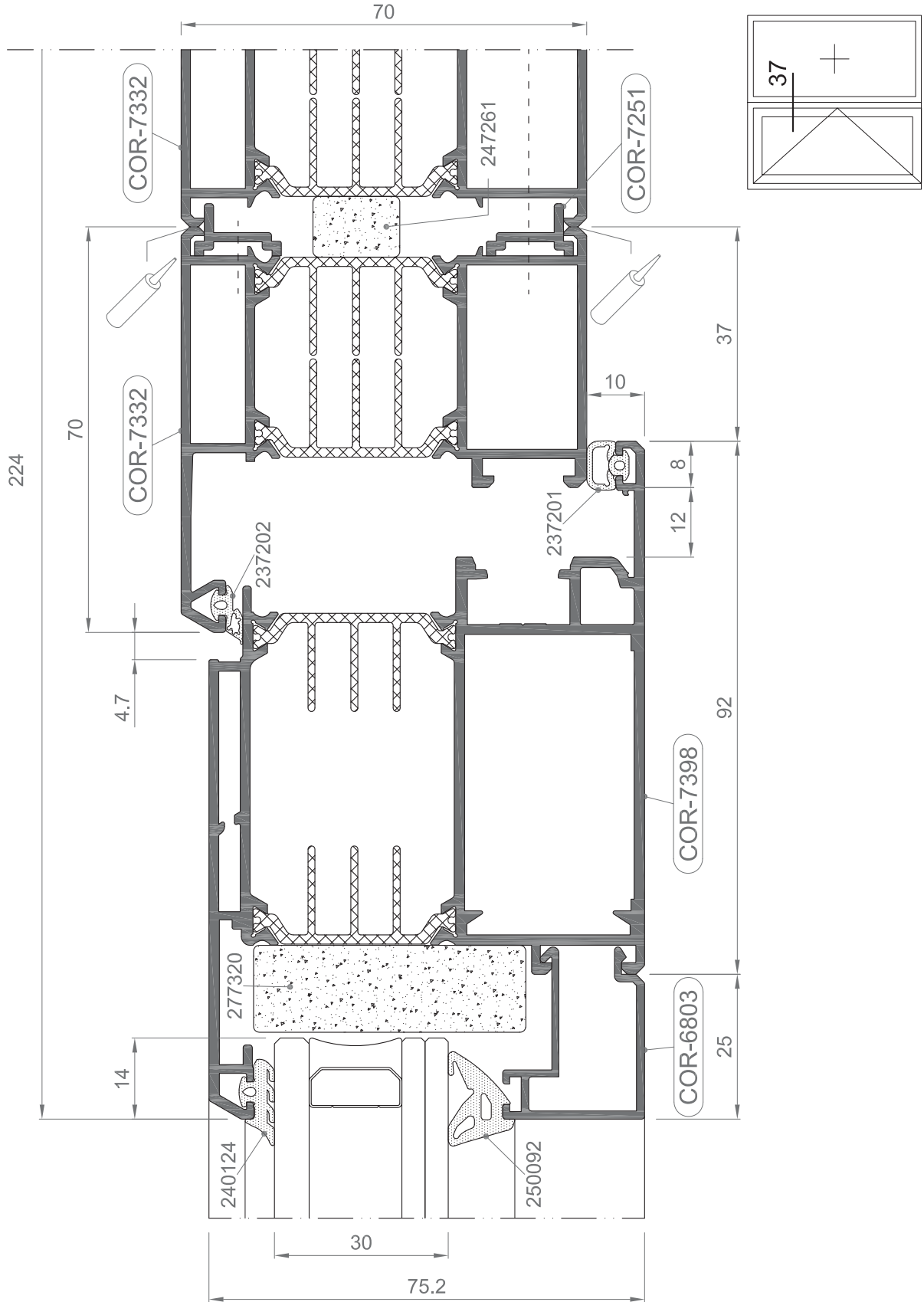

E 1:1

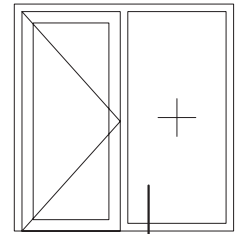

38

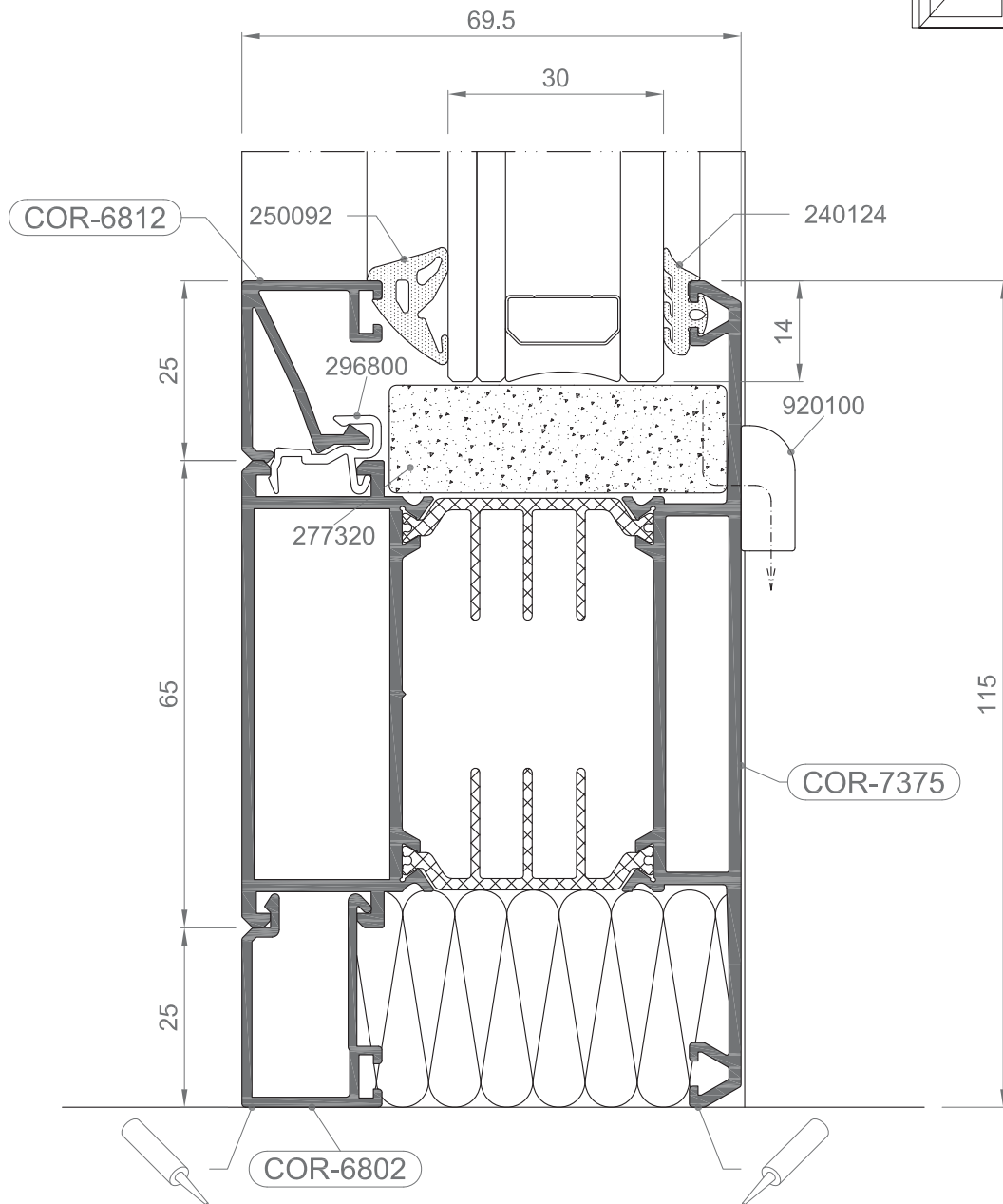

E 1:1

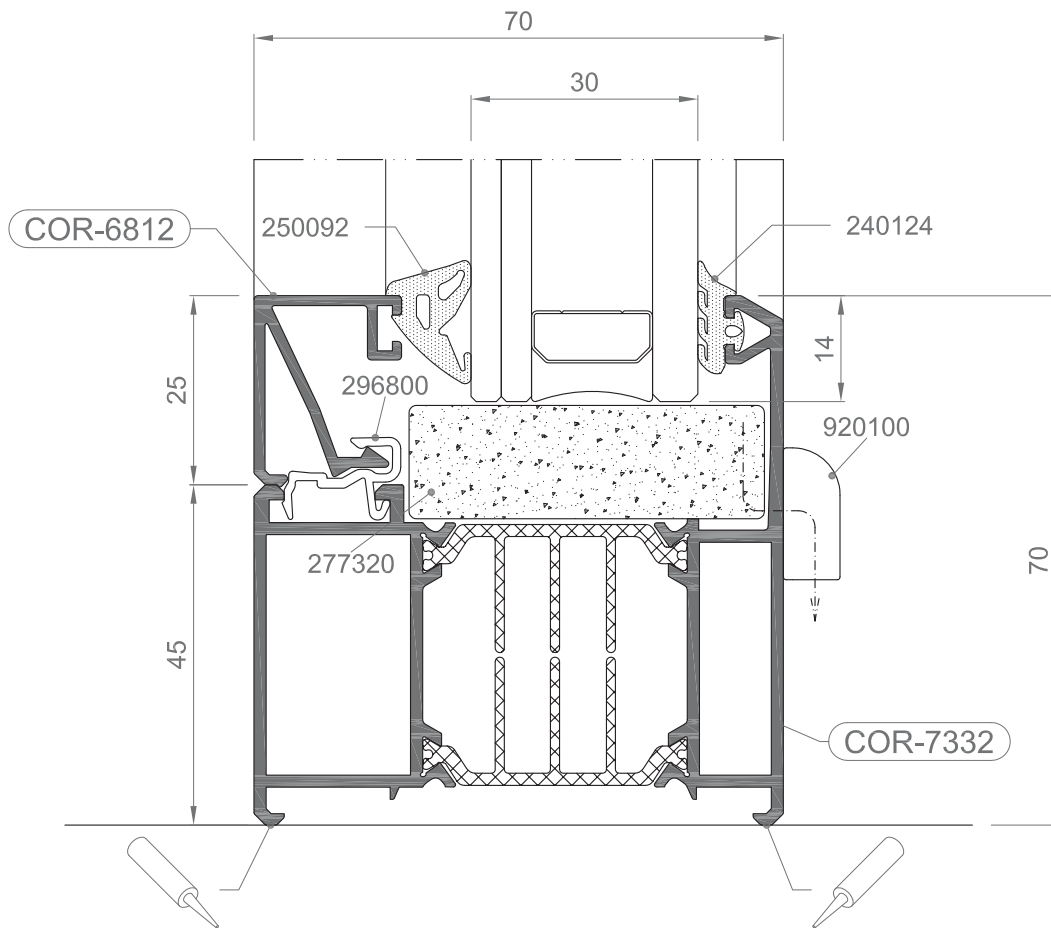
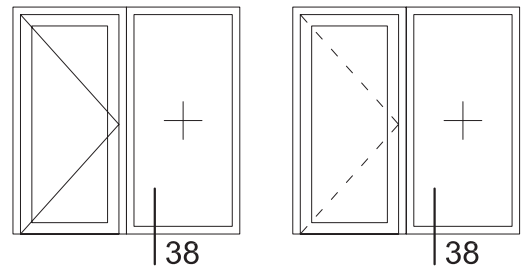

E 1:1

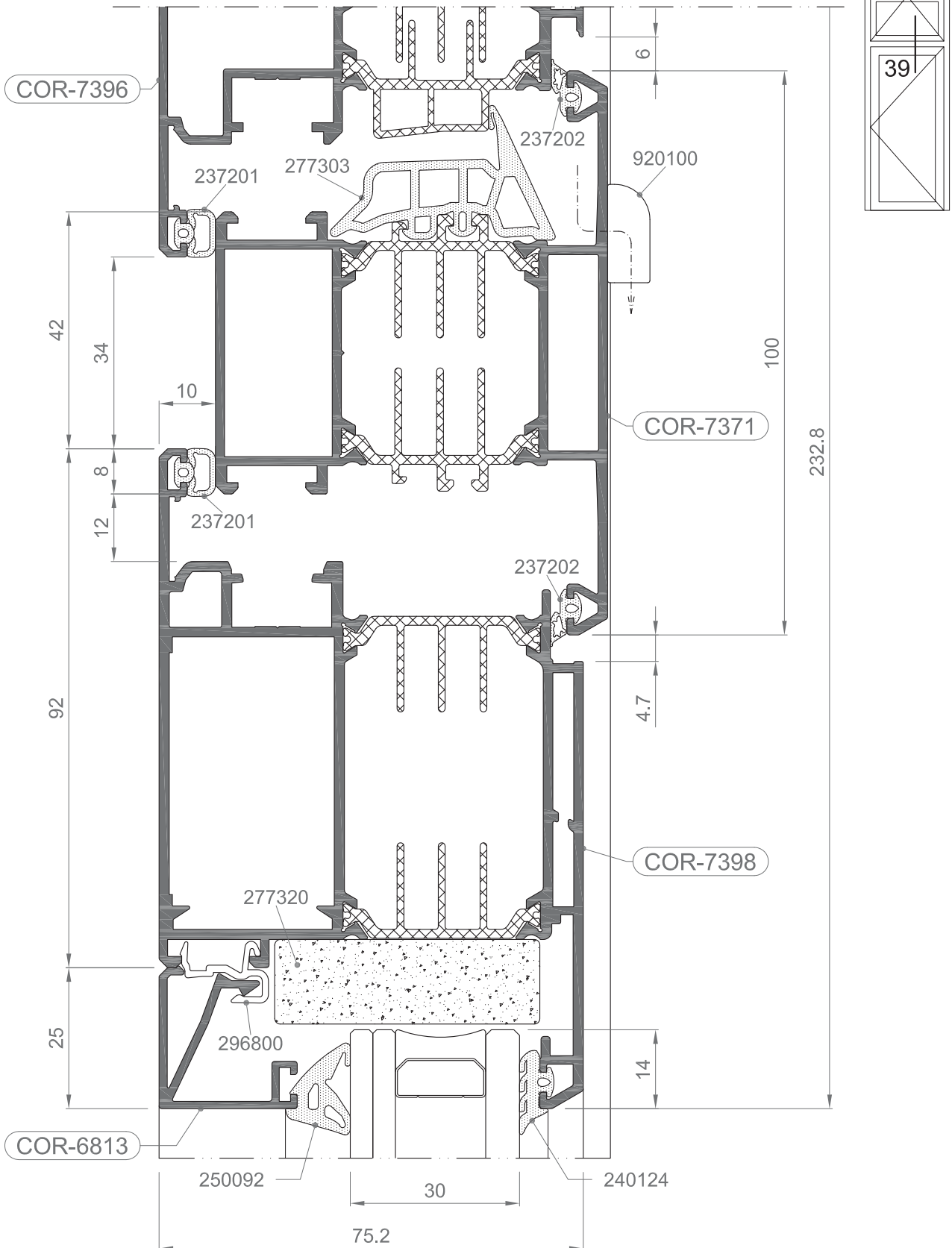

COR 70 CC16

Nudos constructivos

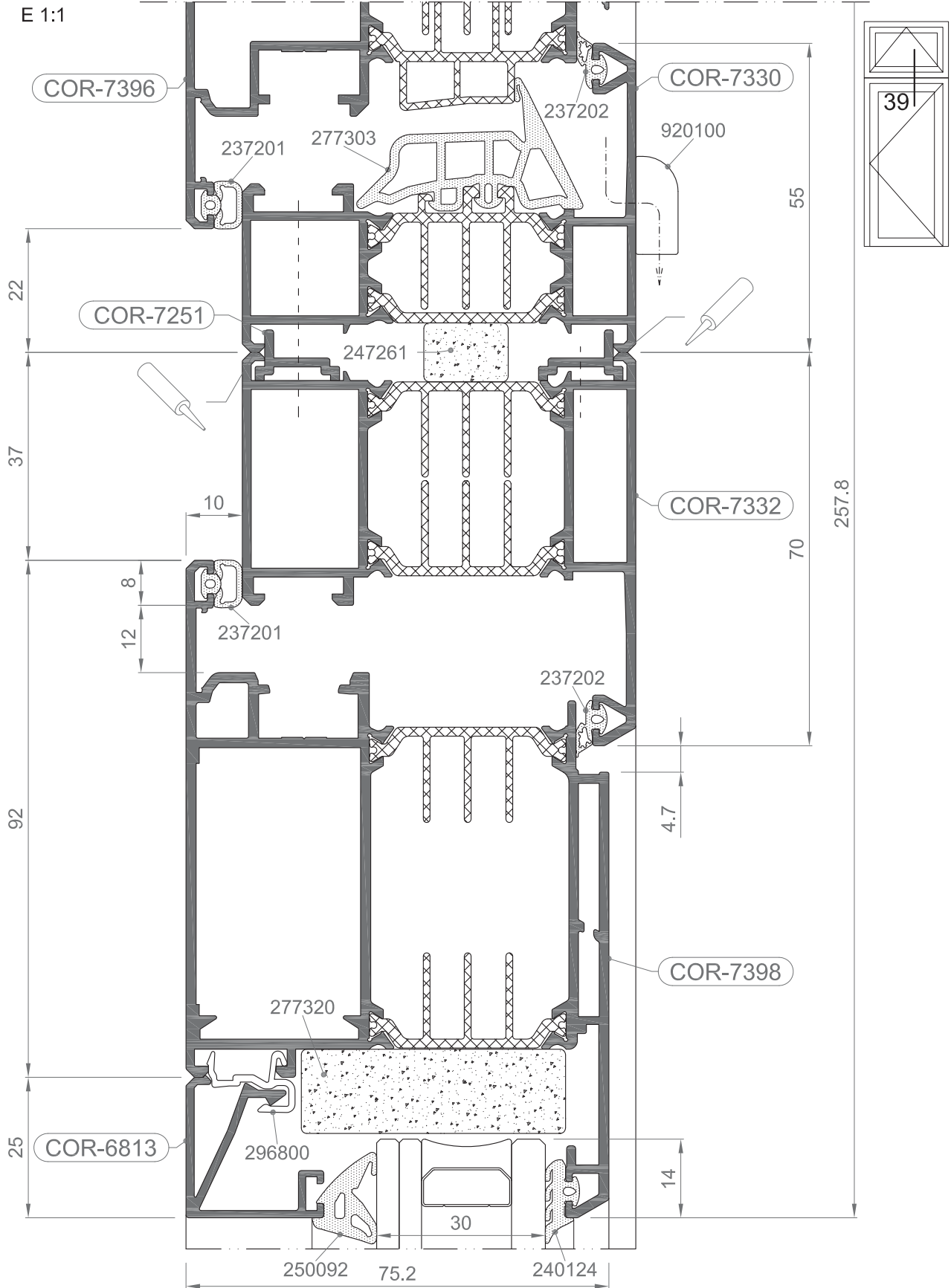

E 1:1

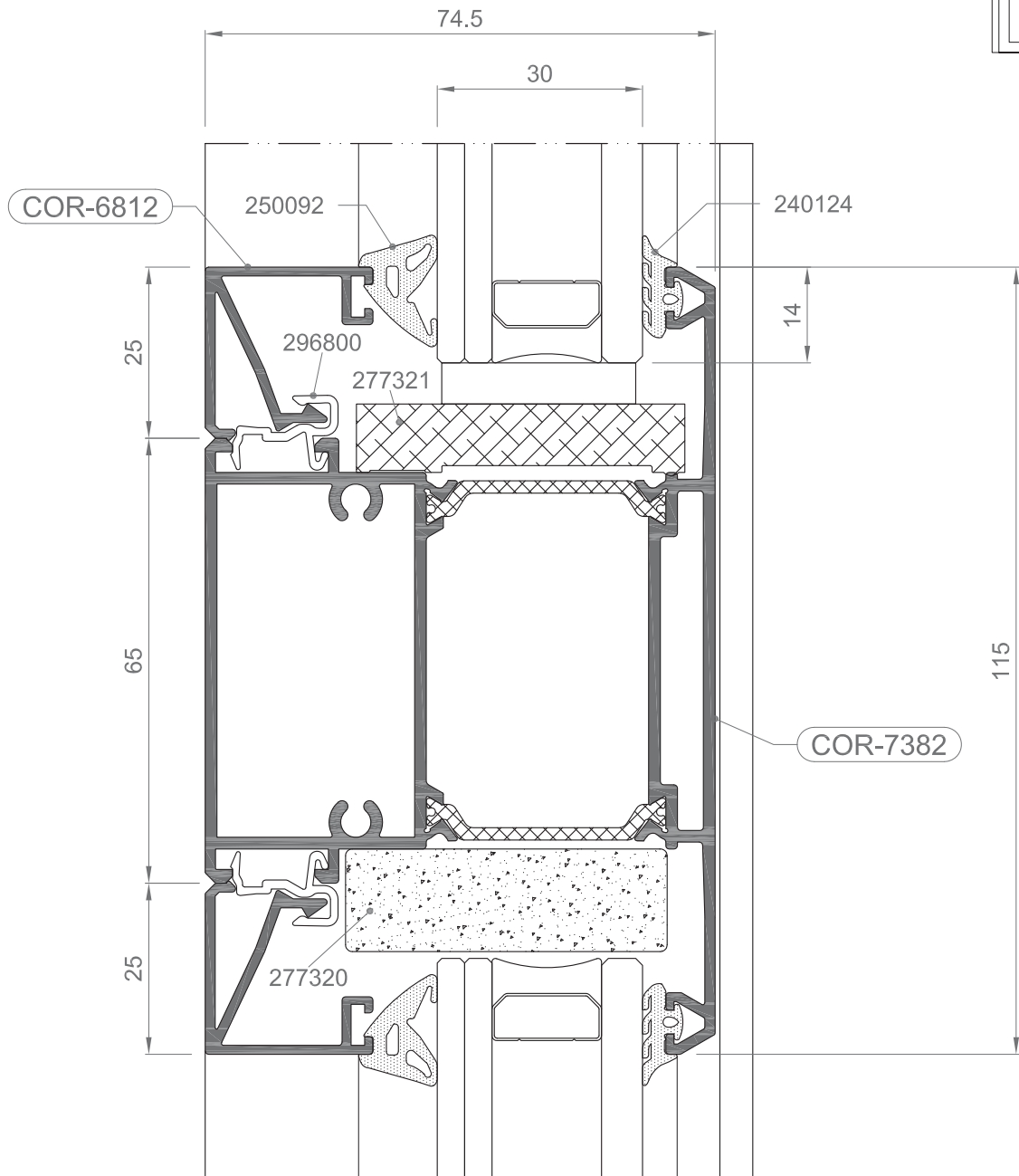
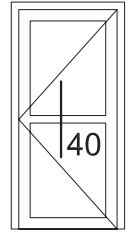

E 1:1

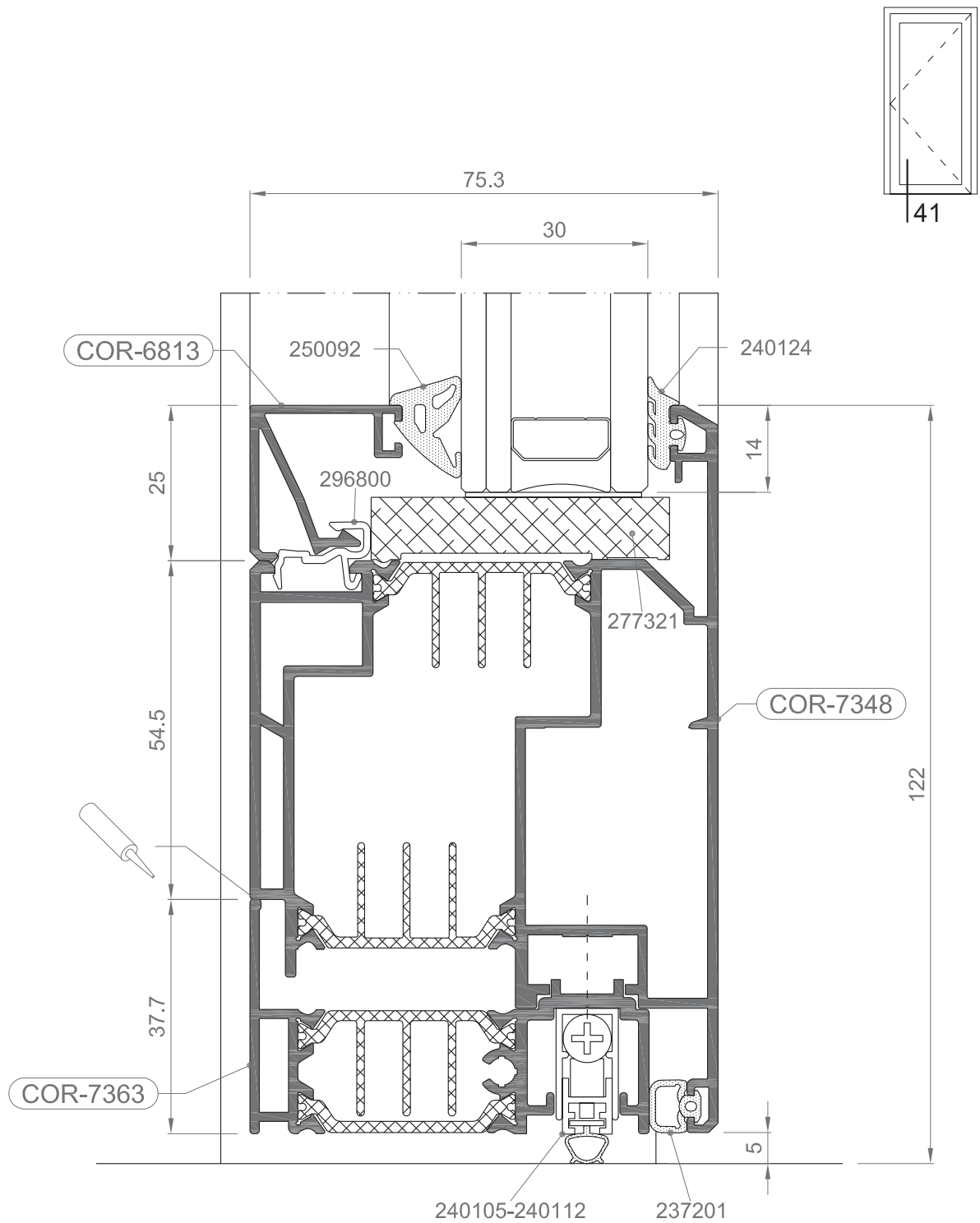

E 1:1

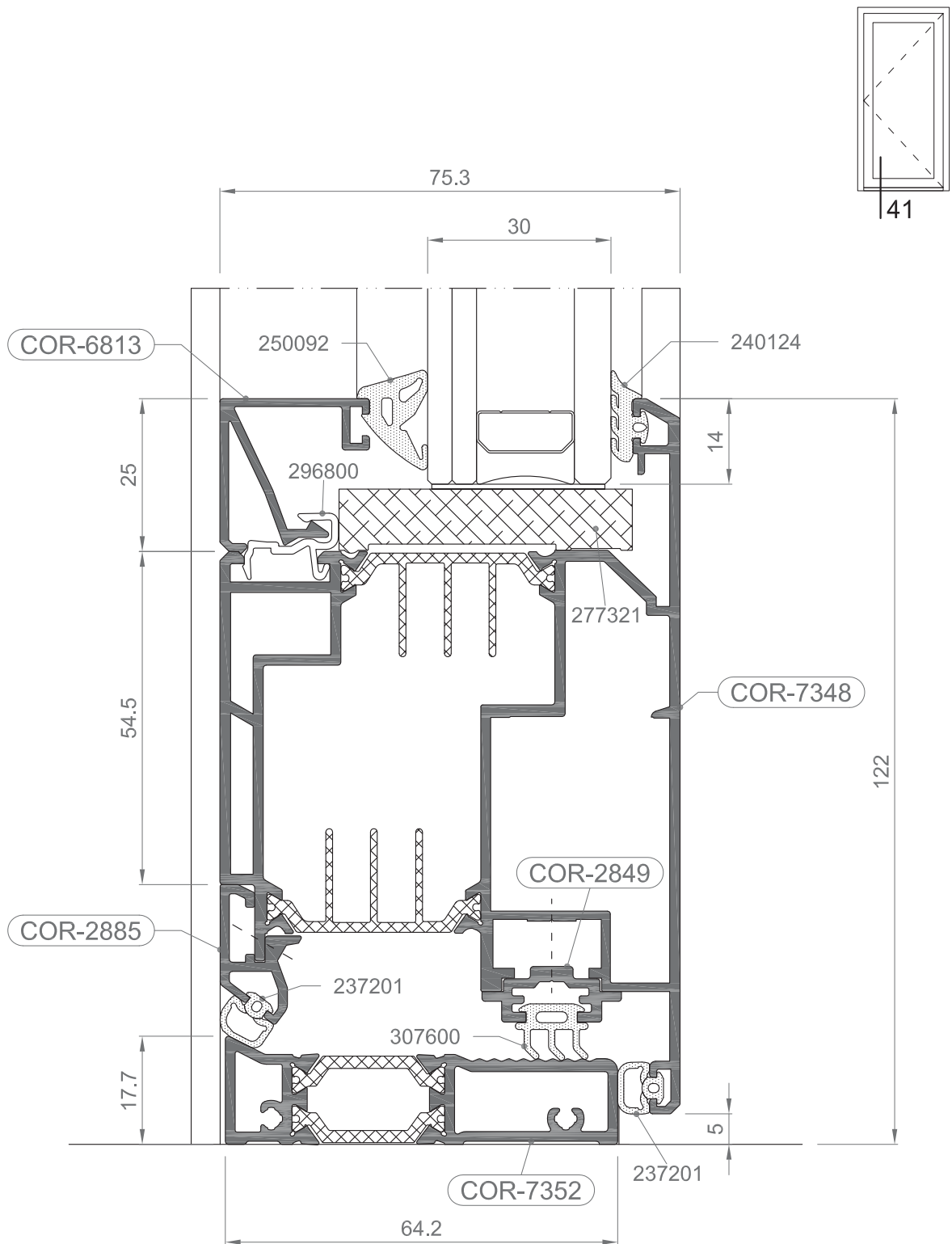

COR 70 CC16

Nudos constructivos

E 1:1

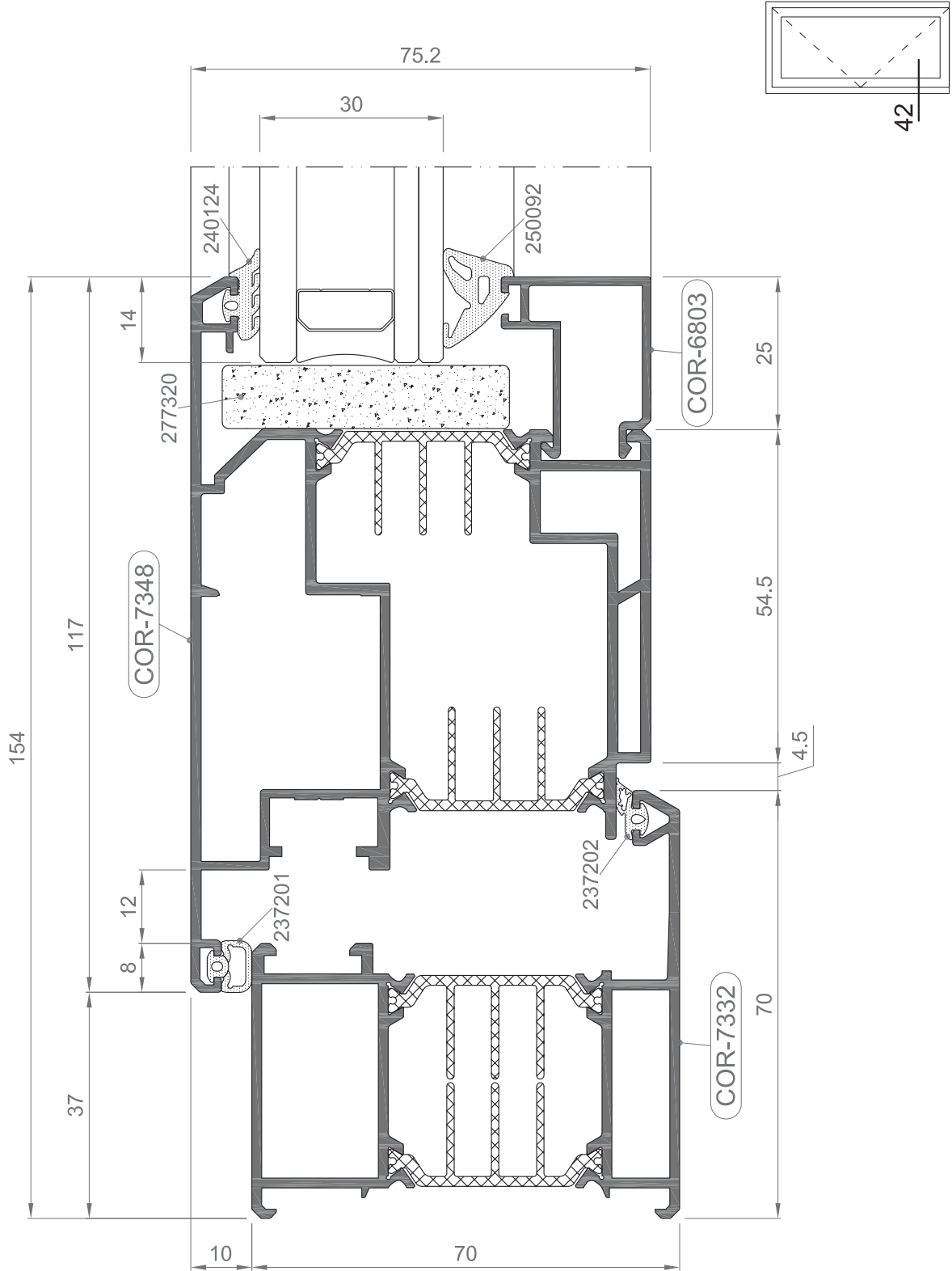

E 1:1

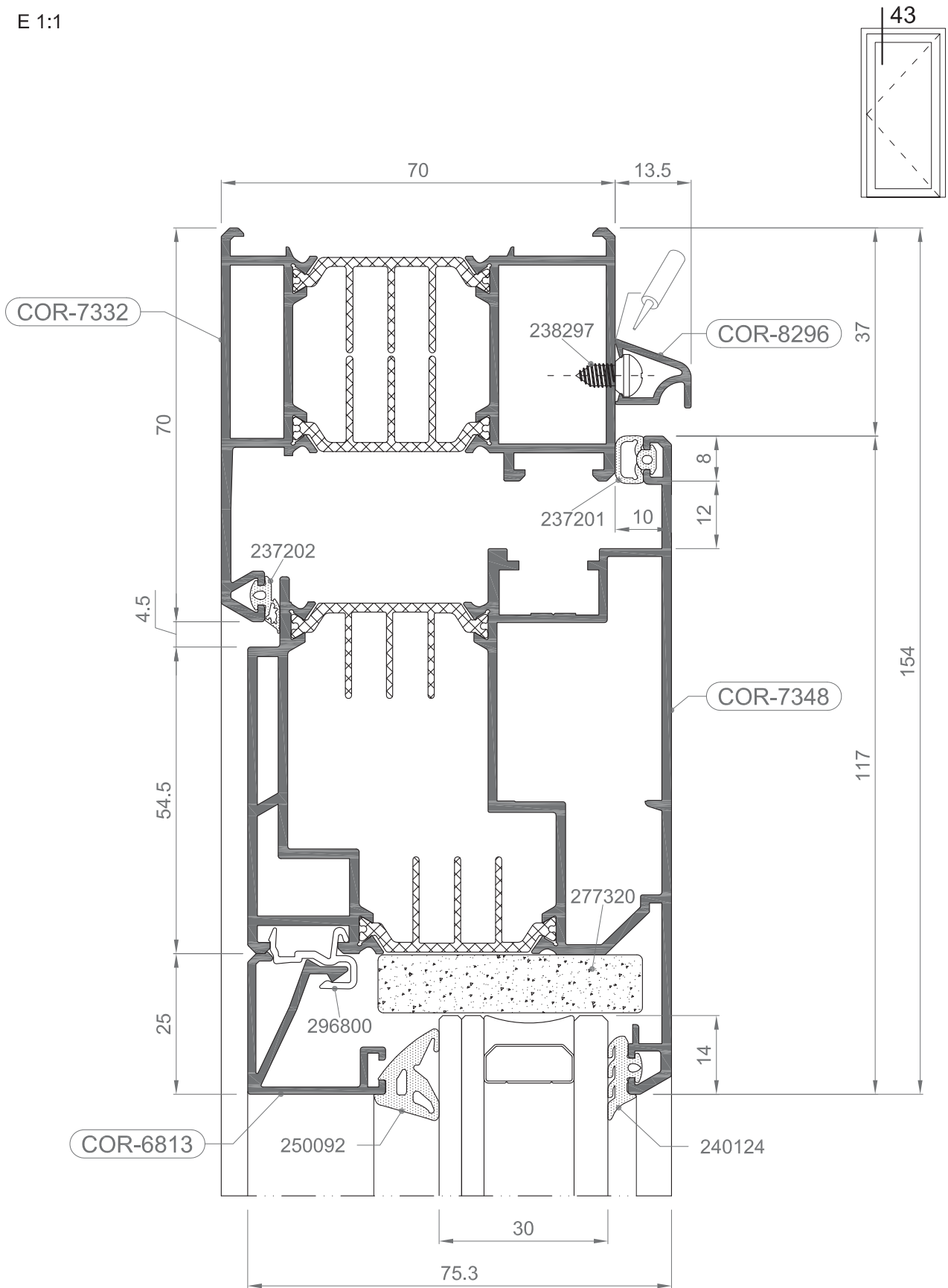

COR 70 CC16

Nudos constructivos

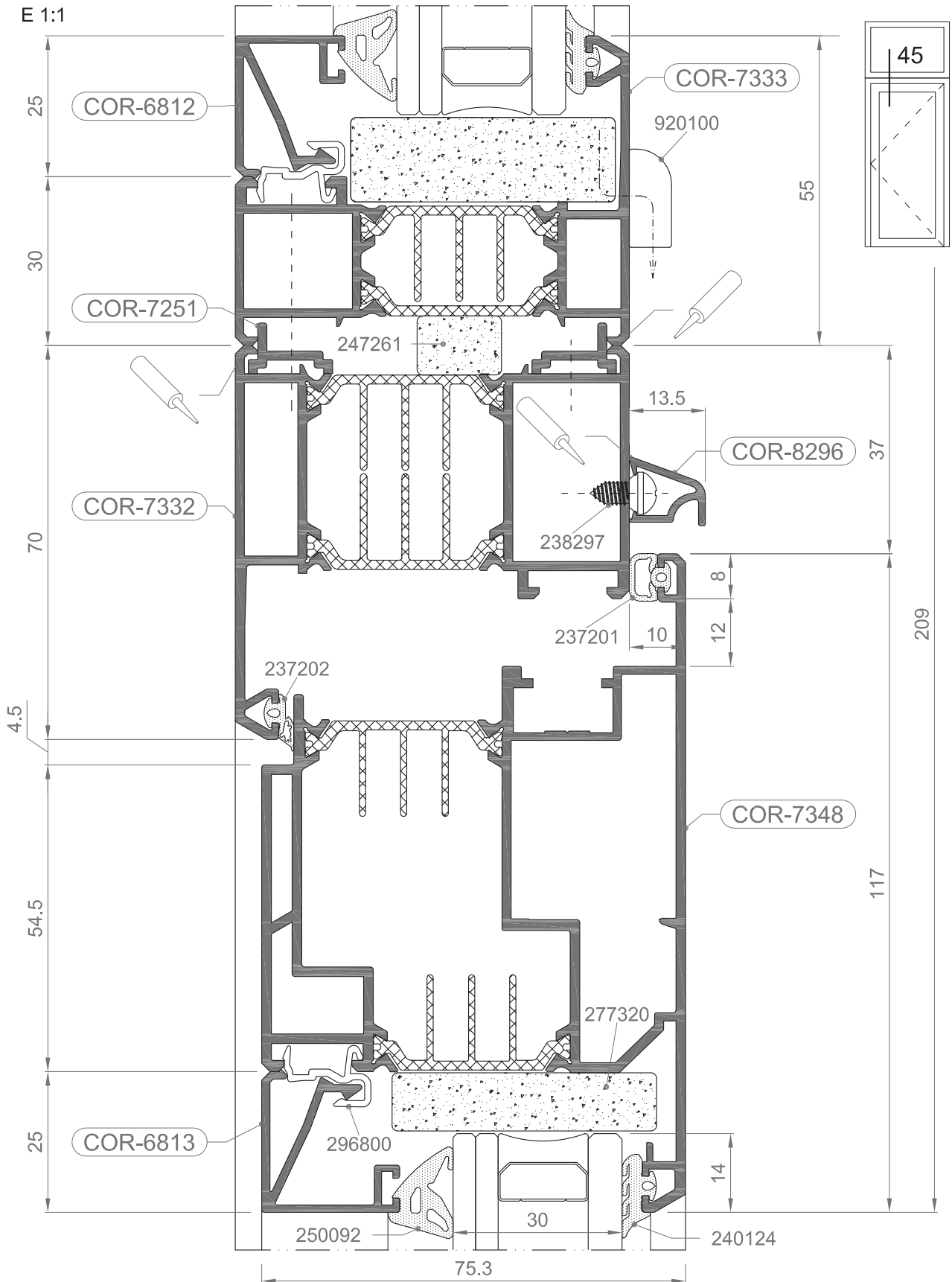

COR 70 CC16

Nudos constructivos

E 1:1

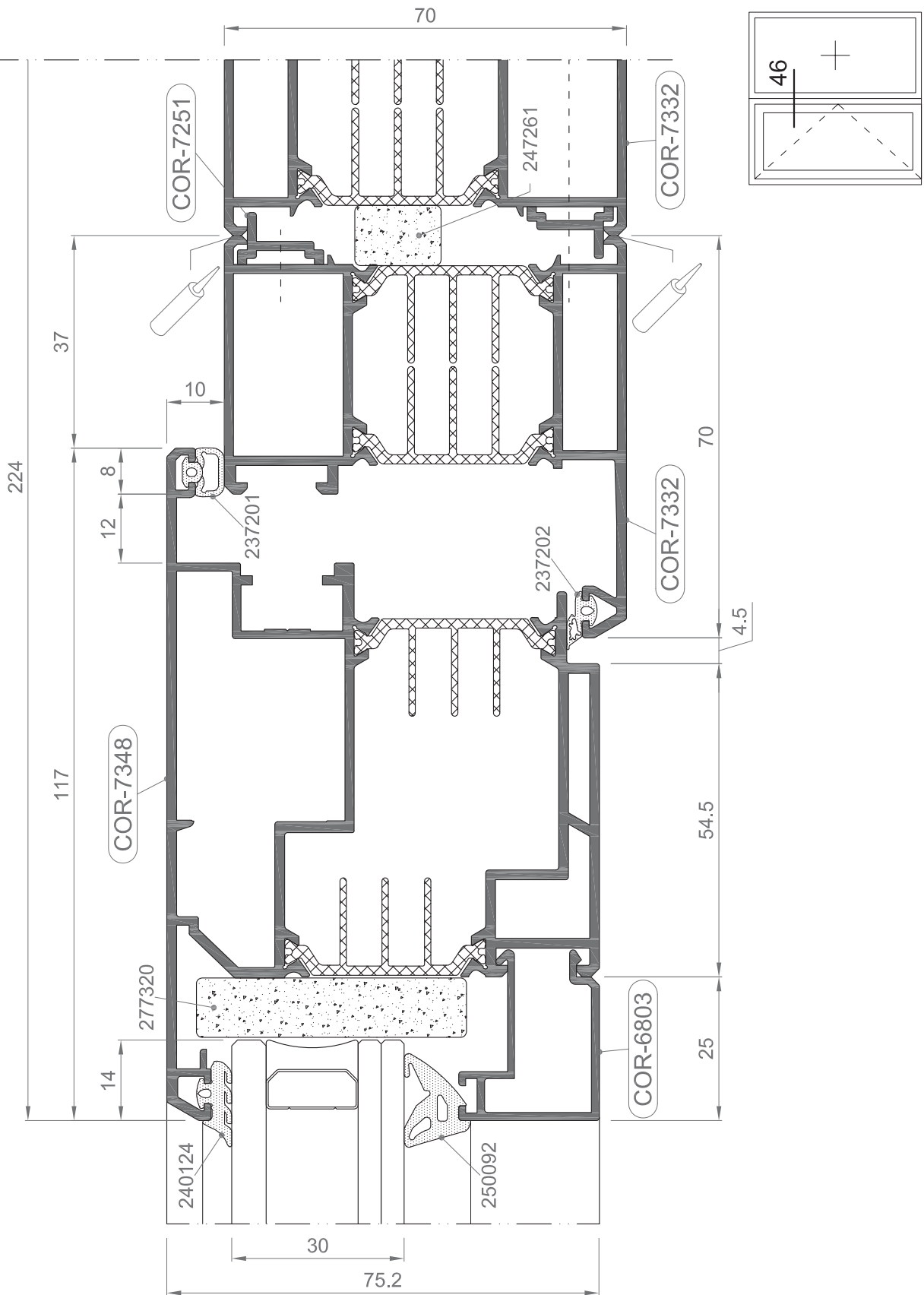

E 1:1

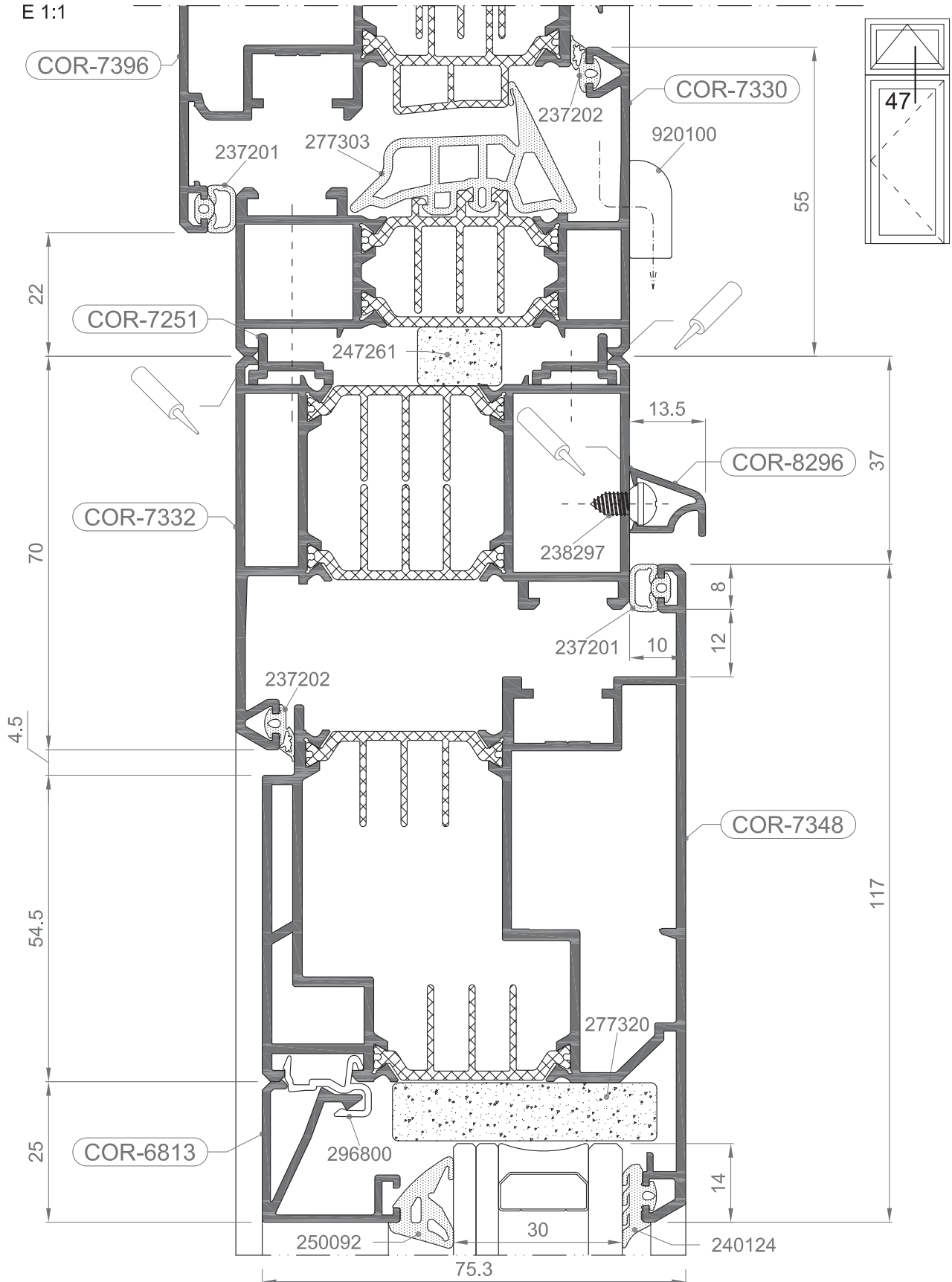

E 1:1

